

Magis — Me Too Collection

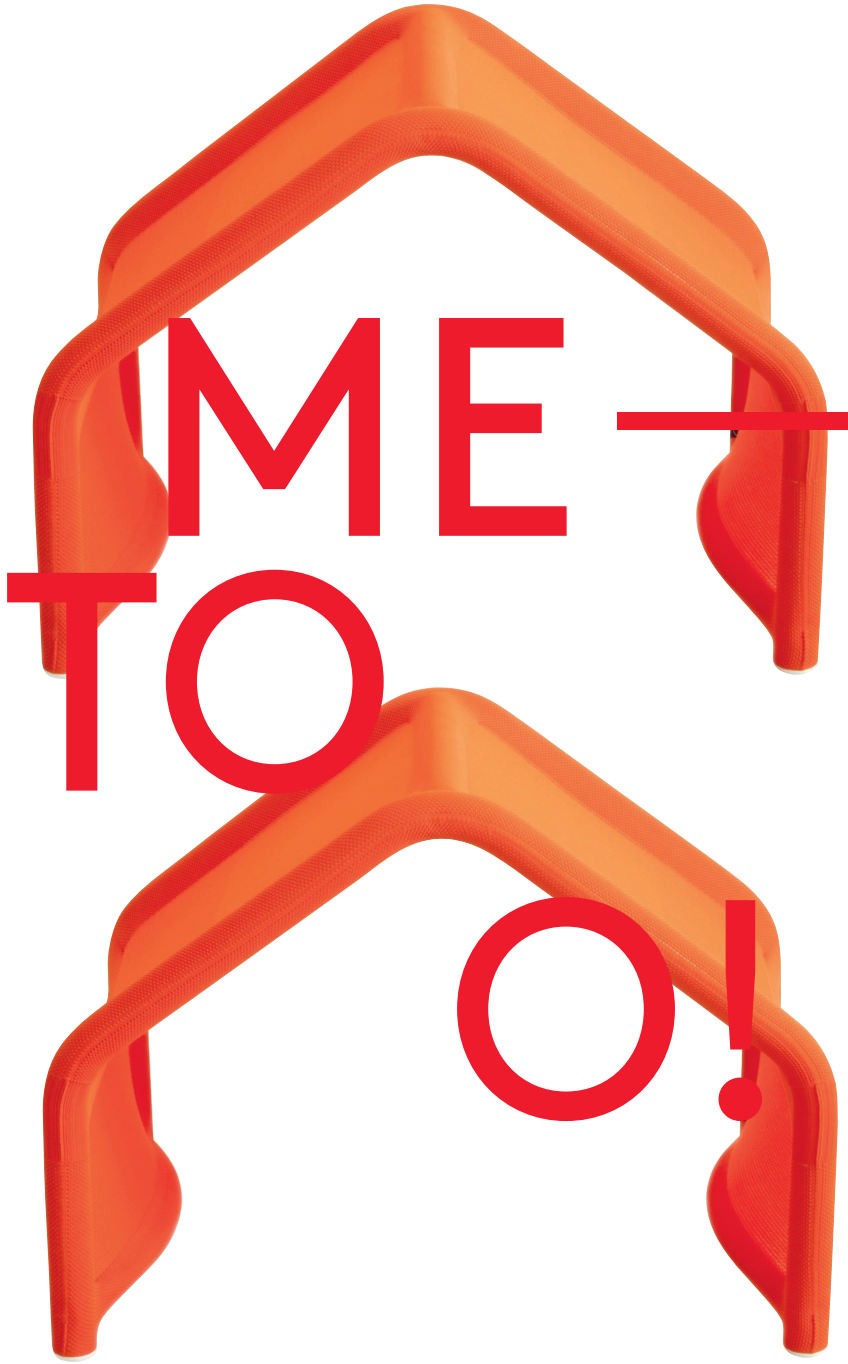

Magis — Me Too Collection

ME  
TO  
O!



## designers

*Me Too was established to create a world made for children. It is the fruit of our encounter with designers from around the world who can still think, look at things and dream like children, together with Magis.*

Me Too nace del deseo de crear un mundo a la medida de los niños y del encuentro con diseñadores de todo el mundo, que todavía saben pensar, mirar y soñar como niños: junto a Magis.

Me Too est issu de deux choses : le désir de créer un monde à la mesure des enfants et la rencontre avec des designers du monde entier qui savent encore penser, regarder et rêver comme les enfants : avec Magis.

Me Too entstand aus dem Wunsch, eine auf Kinder zugeschnittene Welt zu schaffen und aus der Begegnung mit Designern aus aller Welt, die noch wie Kinder denken, schauen und träumen können: gemeinsam mit Magis.

Me Too nasce dal desiderio di creare un mondo a misura di bambino e dall'incontro con designer di tutto il mondo, che sanno ancora pensare, guardare, sognare come i bambini: insieme a Magis.



[Eero Aarnio](#)

Flying Carpet  
Happy Bird  
Pingy  
Puppy  
Trioli



[Big-Game](#)

Little Big



[Floris Hovers](#)

CARtools



[Enzo Mari](#)

Seggiolina Pop



[Giulio Iacchetti](#)

Eur



[Blaise Drummond](#)

Leaves  
Tree



[El Ultimo Grito](#)

Summer to Spring



[Martí Guixé](#)

Football Tape  
My Zoo



[Rogier Martens](#)

Trotter



[Satyendra Pakhalé](#)

Puzzle Carpet



[Marc Newson](#)

Bunky  
Rocky



[Benedetta Mori Ubaldini](#)

Birds  
Clouds  
Fish



[Javier Mariscal](#)

Alma  
El Baúl  
Julian  
Ladrillos  
Linus  
Nido  
Piedras  
Villa Julia



[Spalvieri & Del Ciotto](#)

The Roof Chair

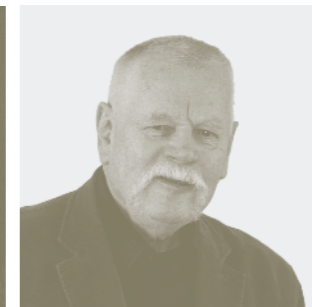

[Oiva Toikka](#)

Dodo  
Downtown  
Moments of Ingenuity  
Paradise Tree



[Marcel Wanders](#)

Little Flare



## index

**alma**<sup>06,34/35, 36, 37</sup> **birds**<sup>16/17, 22</sup> **bunky**<sup>24/25</sup> **CARtools**<sup>56, 57</sup> **clouds**<sup>23</sup> **dodo**<sup>06, 43, 44/45</sup> **downtown**<sup>19, 37</sup>  
**el baúl**<sup>12, 13</sup> **eur**<sup>32, 33, 62/63</sup> **fish**<sup>50, 52/53</sup> **flying**  
**carpet**<sup>28/29</sup> **football tape**<sup>08, 09</sup> **happy bird**<sup>58, 59</sup>  
**julian**<sup>64, 65</sup> **ladrillos**<sup>51, 65</sup> **leaves**<sup>15, 18</sup> **linus**<sup>15, 34/35, 37</sup>  
**little big**<sup>14, 15, 41, 52/53</sup> **little flare**<sup>30, 31, 66/67</sup> **moments**  
**of ingenuity**<sup>16/17, 62/63</sup> **my zoo**<sup>26/27</sup> **nido**<sup>68/69</sup>  
**paradise tree**<sup>42, 51</sup> **piedras**<sup>60/61</sup> **pingy**<sup>20/21</sup>  
**puppy**<sup>30, 33, 38, 39, 46, 47, 62/63</sup> **puzzle carpet**<sup>23, 66/67</sup>  
**rocky**<sup>10/11</sup> **the roof chair**<sup>38, 39, 40, 41</sup> **seggolina**  
**pop**<sup>06, 10/11, 30, 31, 62/63, 66/67</sup> **summer to spring**<sup>48/49</sup>  
**tree**<sup>06, 07</sup> **trioli**<sup>62</sup> **trotter**<sup>52/53, 54, 55</sup> **villa julia**<sup>70/71</sup>

**technical info**<sup>73</sup>



**tree**

by Blaise Drummond  
→107



**alma**

by Javier Mariscal  
→74

**seggiolina**

**pop**

by Enzo Mari  
→105



**dodo**

by Oiva Toikka  
→78



*Spring, summer, autumn,  
winter... in these serigraphies,  
a tree tell us about the cycle  
of the seasons, a story that  
is wonderful because it is true.*

Primavera, verano,  
otoño, invierno... en las  
serigrafías Tree, un árbol  
cuenta el ciclo de las  
estaciones, una fábula  
maravillosa porque es  
verdadera.

Printemps, été,  
automne, hiver... dans  
les sérigraphies Tree, un  
arbre raconte le cycle  
des saisons, une fable  
merveilleuse parce qu'elle  
est vraie.

Frühling, Sommer,  
Herbst und Winter...  
in den Siebdrucken Tree  
erzählt ein Baum den  
Wechsel der Jahreszeiten,  
ein wunderbares Märchen,  
weil es wahr ist.

Primavera, estate,  
autunno, inverno... nelle  
serigrafie Tree, un albero  
racconta il ciclo delle  
stagioni, una favola  
meravigliosa perché vera.



**tree**

by Blaise Drummond  
→107

**Football Tape turns an ordinary  
scrunched-up newspaper  
into a football: straight into  
the net!**



**football tape**

by Martí Guixé  
→84

Football Tape transforma un sencillo periódico arrugado en un balón de fútbol: y es en seguida gol.

Football Tape transforme un simple journal roulé en boule en un ballon de foot : but !

Football Tape verwandelt eine zerknüllte Zeitung in einen Fussball: und sofort ein Tor!

Football Tape trasforma un semplice giornale appallottolato in un pallone da calcio: ed è subito goal.



**Two ways of sitting without  
ever being still. Rocky, the unbeatable,  
indestructible rocking horse.  
Pop, the light seat that can take  
anything.**

Dos maneras de sentarse  
sin estarse nunca quietos.  
Rocky, el invencible e  
indestructible caballito  
balancea Pop, la sillita ligera  
pero resistente a todo.

Deux façons de s'asseoir  
sans jamais rester immobiles.  
Rocky, le cheval à bascule  
invincible et indestructible.  
Pop, la petite chaise légère  
qui résiste à tout.

Zwei Arten zu sitzen, aber  
immer in Bewegung bleiben.  
Rocky, das unbesiegbare,  
unzerstörbare Schaukelpferd.  
Pop, ein leichter Kinderstuhl,  
der aber alles aushalten kann.

Due modi di sedersi  
senza stare mai fermi. Rocky,  
l'invincibile e indestructibile  
cavallo a dondolo. Pop,  
la seggiolina leggera ma  
resistente a tutto.



**rocky**

by Marc Newson  
→103



**seggiolina  
pop**

by Enzo Mari  
→105

*El Baúl, the chest for your treasure. A friend that always has room for favourite toys, costumes for dressing up or secrets to be hidden before the pirates get ready to board.*

**el baúl**

by Javier Mariscal  
→80



Quien tiene El Baúl tiene un tesoro. Un amigo en el que caben todos los juegos preferidos, los vestidos para disfrazarse, los secretos que hay que esconder, antes de que lleguen los piratas.

Celui qui trouve El Baúl trouve un trésor. Un ami qui fait de la place à tous tes jouets préférés, à tes déguisements et aux secrets à cacher avant l'arrivée des pirates.

Wer El Baúl findet, findet einen Schatz. Ein Freund, in dem das Lieblingsspielzeug Platz findet, Verkleidungen, geheime Schätze, die es vor Piraten zu verstecken gilt.

Chi trova El Baúl trova un tesoro. Un amico che dà spazio a tutti i giochi preferiti, i vestiti per travestirsi, i segreti da nascondere, prima che arrivino i pirati.





**little big**

by Big-Game  
→92

**Little Big, thinking big for little people. From the chair to the table, both height-adjustable, to mirrors in which to play with your reflection.**

Little Big, pensados en grande para los más pequeños. De la silla a la mesa, ambos de altura regulable, a los espejos para jugar con la propia imagen.

Little Big, pensés en grand pour les plus petits. De la chaise à la table, toutes deux réglables en hauteur, aux miroirs pour jouer avec sa propre image.

Little Big, im Grossen gedacht für unsere Kleinen. Vom Stuhl zum Tisch, beide in der Höhe verstellbar, zu den Spiegeln, um mit dem eigenen Bild zu spielen.

Little Big, pensati in grande per i più piccoli. Dalla sedia al tavolo, entrambi regolabili in altezza, agli specchi per giocare con la propria immagine.



**leaves**

by Blaise Drummond  
→89

**little big**

by Big-Game  
→91

**linus**

by Javier Mariscal  
→90

Leaves — Castanea sativa (Chestnut), serigraphy  
Little Big, children's chair  
Linus, children's table



birds

by Benedetta Mori Ubaldini  
→75



moments  
of ingenuity

by Oiva Toikka  
→95



# Cultivating creativity and a sense of aesthetics. Leaves that become screen-printed works of art. Or use a skyscraper as a bookcase with Downtown.

Cultivar la fantasía y el sentido estético. Hojas que se convierten en obras de arte, en las serigrafías Leaves. Usar un rascacielos como librería, con Downton.

Cultiver l'imagination et le sens esthétique. Des feuilles qui deviennent œuvre d'art, dans les sérigraphies Leaves. Utiliser un gratte-ciel comme bibliothèque, avec Downtown.

Fantasie und den Sinn für Schönheit pflegen. Blätter, die in den Siebdrucken Leaves zum Kunstwerk werden. Einen Wolkenkratzer als Bücherregal nutzen, mit Downtown.

Coltivare la fantasia e il senso estetico. Foglie che diventano opera d'arte, nelle serigrafie Leaves. Usare un grattacielo come libreria, con Downtown.



leaves

by Blaise Drummond  
→89



downtown

by Oiva Toikka  
→79



**Animals always play a special role in the life of a child. Perhaps Pingy has eaten too much, that's why he's so funny as he rocks on his tummy.**

Los animales siempre tienen un espacio especial en la vida de los niños. Pingy tal vez haya comido demasiado, por eso es tan gracioso mientras se mece sobre su tripa.

Les animaux occupent toujours une place spéciale dans la vie des enfants. Pingy a sans doute trop mangé, voilà pourquoi il est aussi drôle lorsqu'il se balance sur le ventre.

Tiere spielen im Leben von Kindern immer eine wichtige Rolle. Pingy hat vielleicht ein wenig zu viel gefressen, aber deshalb ist er auch so drollig, wenn er am Bauch hin und her schaukelt.

Gli animali hanno sempre uno spazio speciale nella vita dei bambini. Pingy forse ha mangiato un po' troppo, ecco perché è così buffo mentre dondola sulla pancia.



pingy

by Eero Aarnio  
→100

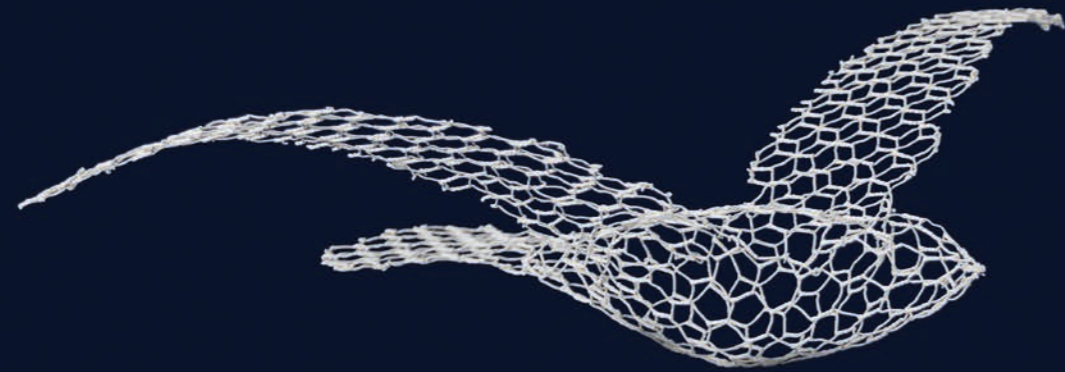

## birds

by Benedetta Mori Ubaldini  
→75

***Birds and Clouds dangle on a thread, they play with the air and light, telling stories that are always different, like the Puzzle Carpet.***

Birds y Clouds se balancean colgando de un hilo, juegan con el aire y la luz, cuentan historias distintas cada vez, como la alfombra Puzzle Carpet.

Birds et Clouds se balancent, pendus à un fil ; ils jouent avec l'air et la lumière, ils racontent des histoires toujours différentes, tout comme le tapis Puzzle Carpet.

Birds und Clouds sind auf einer Schnur aufgehängt und schaukeln in Luft und Licht, erzählen immer neue Geschichten wie der Teppich Puzzle Carpet.

Birds e Clouds dondolano appesi a un filo, giocano con l'aria e la luce, raccontano storie sempre diverse, come il tappeto Puzzle Carpet.



## clouds

by Benedetta Mori Ubaldini  
→75

## puzzle carpet

by Satyendra Pakhalé  
→102

## bunky

by Marc Newson  
→76



Bunky es una torre de colores que se puede construir al gusto de cada uno en la que dormir, jugar, leer, escuchar y hacer todo lo que se quiera.

Bunky est une tour colorée que tu peux construire à ton gré et dans laquelle tu peux dormir, jouer, lire, grimper et faire tout ce que tu veux.

Bunky ist ein bunter Turm, den man beliebig bauen kann, wo man schlafen, spielen, lesen und auf den man klettern kann, ganz wie man will.

Bunky è una torre colorata che si può costruire a piacimento, dove dormire, giocare, leggere, arrampicarsi, fare tutto quello si vuole.

**Bunky is a colourful tower  
to build as you like,  
where you can sleep, play,  
read, climb or do anything  
you like.**



The animals of My Zoo  
are fun to build like giant toys  
and you can colour them  
with all the colours you want.

my zoo

by Martí Guixé  
→96

Los animales de My Zoo se construyen como juguetes gigantes y se pueden pintar con todos los colores que uno quiera. ¡Empieza la diversión!

Les animaux de My Zoo sont amusants à construire comme des jouets gigantesques que tu peux colorier de toutes les couleurs qui te plaisent.

Die Tiere von My Zoo lassen sich zu lustigen Riesenspielzeugen zusammenbauen, die man bunt bemalen kann.

Gli animali di My Zoo sono divertenti da costruire come giocattoli giganti e liberi da colorare con tutti i colori che si vuole.

*After each flight,  
Flying Carpet can be parked  
in the house,  
or outdoors on its rocker base.*

Tras cada vuelo, Flying Carpet se puede aparcar tranquilamente en casa o en el exterior, sobre su plataforma oscilante.

Après chaque vol, tu peux tranquillement garer Flying Carpet dans la maison ou dehors, sur sa plate-forme oscillante.

Nach jedem Flug kann Flying Carpet unbesorgt daheim oder im Freien auf seiner schwankenden Plattform geparkt werden.

Dopo ogni volo, Flying Carpet si può tranquillamente parcheggiare in casa oppure anche all'aperto, sulla sua piattaforma oscillante.



**flying carpet**

by Eero Aarnio  
→83



**seggolina**  
**pop**  
by Enzo Mari  
→105

**little flare**  
by Marcel Wanders  
→94



**puppy**  
by Eero Aarnio  
→101

**eur**  
by Giulio Iacchetti  
→81



Alma, children's chair  
Linus, children's table

alma+linus

by Javier Mariscal  
→74+90



**alma**

by Javier Mariscal  
→74



**downtown**

by Oiva Toikka  
→79

**alma+linus**

by Javier Mariscal  
→74+90



**the roof  
chair**

by Spalvieri & Del Ciotto  
→104

**puppy**

by Eero Aarnio  
→101

*Is it a house, a tunnel,  
a slide, or a roof from which  
to view the world?  
The Roof Chair is all this  
and more: soft, technological  
and creative.*

¿Es una casita,  
un túnel, un tobogán, un  
tejado desde el que mirar  
el mundo? The Roof Chair  
es todo esto y más: suave,  
tecnológico, creativo.

Est-ce une petite  
maison, un tunnel,  
un toboggan, un toit d'où  
observer le monde ?  
The Roof Chair est tout  
cela et beaucoup plus :  
douce, technologique,  
créative.

Ein kleines Haus, ein  
Tunnel, eine Rutsche, ein  
Dach, von dem man auf  
die Welt hinunterschauen  
kann? The Roof Chair ist  
all das, und ausserdem  
kuschelig, technologisch  
und kreativ.

È una casetta,  
un tunnel, uno scivolo, un  
tetto dal quale guardare  
il mondo? The Roof Chair  
è tutto questo e anche di  
più: morbido, tecnologico,  
creativo.

**the roof  
chair**

by Spalvieri & Del Ciotto  
→104



**little big**

by Big-Game  
→92





paradise tree

by Oiva Toikka  
→98

***Dodo is the mythical rocking bird that finds its natural habitat in the home or the garden. Paradise Tree is a coat stand where a cat, a bird and a load of clothes live happily together.***



Dodo es un exótico pájaro balancín que encuentra su hábitat natural en casa o en el jardín. Paradise Tree es la percha en la que conviven felices un gato, un pájaro y toda la ropa.

Dodo est le célèbre oiseau à bascule qui trouve son habitat naturel à la maison ou dans le jardin. Paradise Tree est le portemanteau sur lequel cohabitent en harmonie un chat, un oiseau et tous tes vêtements.

Dodo ist eine Vogelschaukel, die daheim und im Garten in ihrem Element ist. Paradise Tree ist ein Kleiderständer, auf dem eine Katze, ein kleiner Vogel und alle Kleider friedlich miteinander leben.

Dodo è il mitico uccello a dondolo che trova un habitat naturale in casa o in giardino. Paradise Tree è l'appendiabiti sul quale convivono felici un gatto, un uccellino e tutti i vestiti.

**dodo**by Oiva Toikka  
→78

dodo

by Oiva Toikka  
→78



*Puppy isn't just any dog.  
He's as a child imagines a dog  
when drawing one for the first  
time: head, body, paws.  
That's why he's so fantastic,  
including his colours.*



Puppy no es un perro cualquiera, sino un cachorro imaginado por un niño cuando lo dibuja por primera vez: cabeza, cuerpo, patas. Por eso es tan fantástico, incluso en los colores.

Puppy n'est pas un chien comme les autres, mais un chiot imaginé par un enfant, quand il le dessine pour la première fois : tête, corps, pattes. C'est pour ça qu'il est génial : même au niveau des couleurs.

Puppy ist nicht irgendein Hund, Puppy ist ein Hundebaby, so wie es ein Kind zum ersten Mal zeichnen würde: Kopf, Körper, Pfoten. Deshalb ist es auch so fantasievoll: auch in den Farben.

Puppy non è un cane qualsiasi, ma un cucciolo immaginato da un bambino, quando lo disegna la prima volta: testa, corpo, zampe. Ecco perché è così fantastico: anche nei colori.

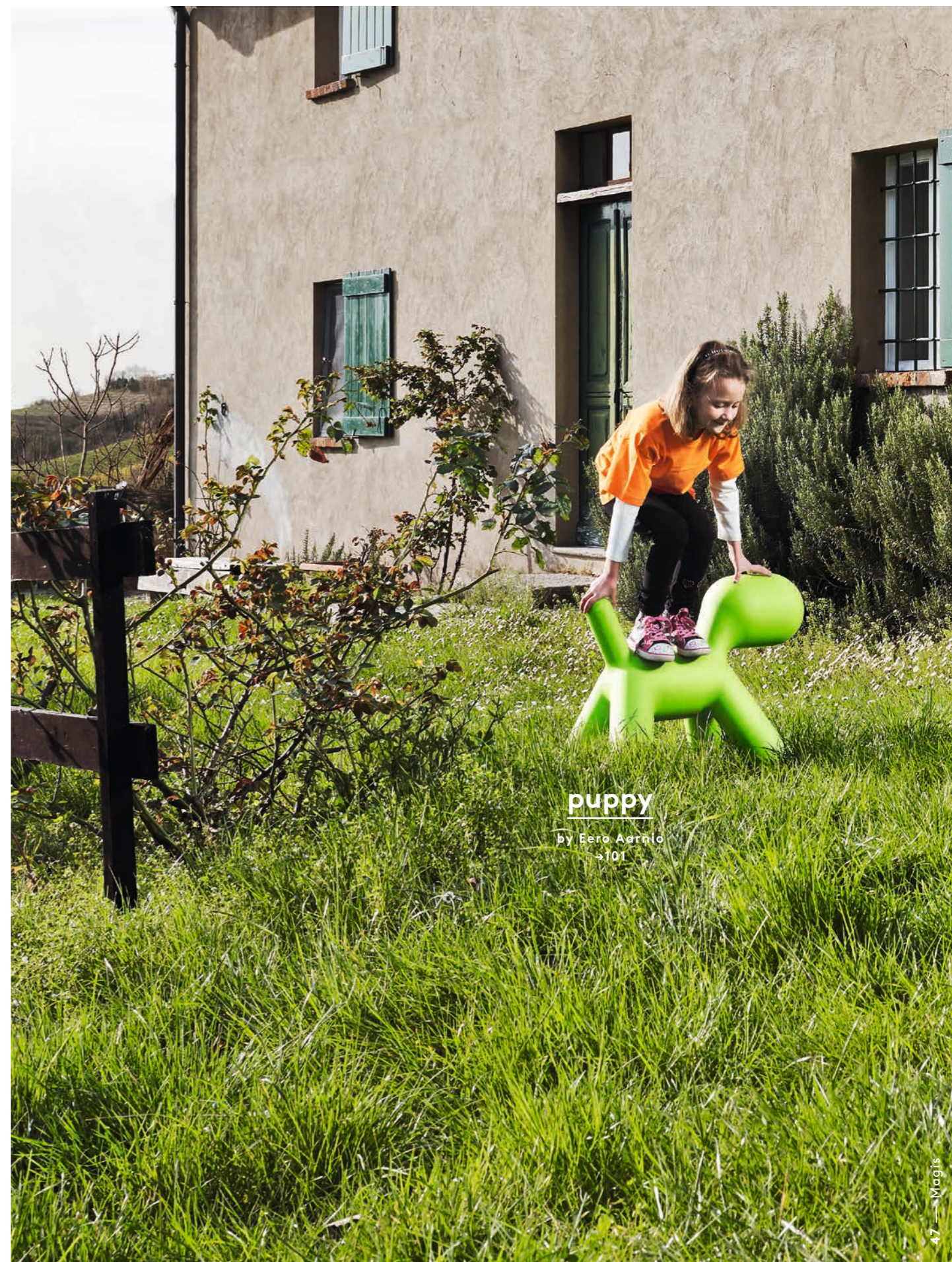

**puppy**

by Eero Aarnio  
→ 101



single

micelin

times  
table

dress

numbers

piggy  
bank

two

skirt

trousers

summer  
to  
spring

by El Ultimo Grito  
→106

*Fish dives into the depths of dreams and creates an upside-down world, where fish float in the air.*

**fish**

by Benedetta Mori Ubaldini  
→82

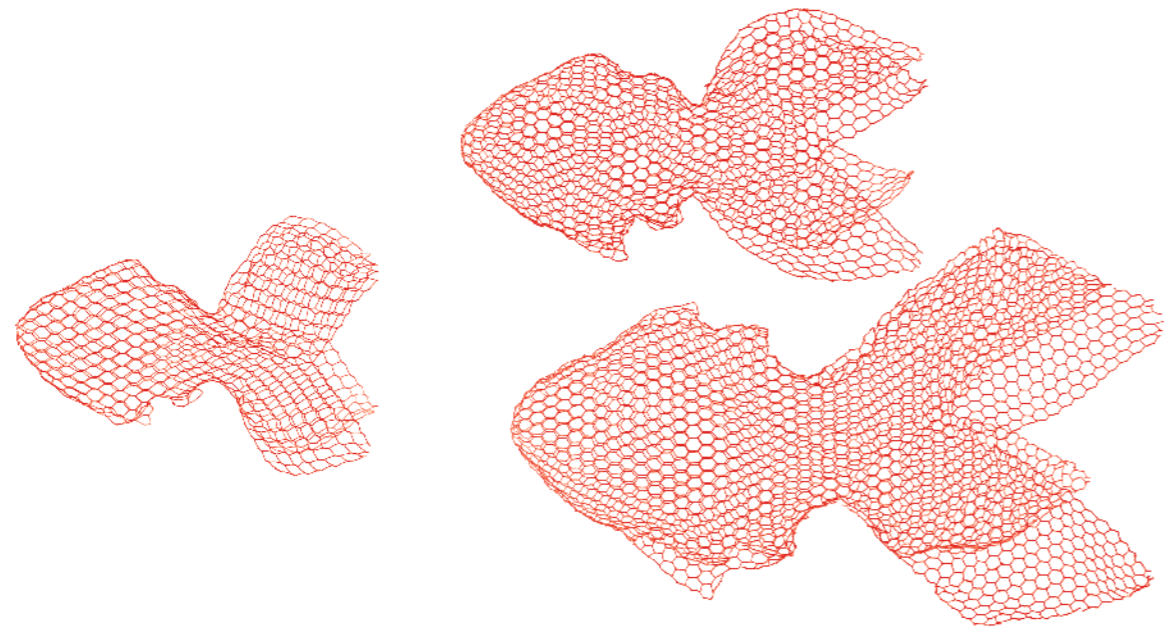

Fish se sumerge en las profundidades del sueño y da vida a un mundo del revés, donde los peces flotan en el aire.

Fish s'immerge dans les profondeurs des rêves et donne vie à un monde à l'envers, où les poissons flottent dans l'air.

Fish taucht in die Tiefe der Träume ein und erweckt eine umgekehrte Welt zum Leben, in der Fische durch die Lüfte schweben.

Fish si immerge nelle profondità dei sogni e dà vita a un mondo capovolto, dove i pesci fluttuano nell'aria.



**ladrillos**

by Javier Mariscal  
→88

**paradise tree**

by Oiva Toikka  
→98

Ladrillos, shelving system  
Paradise Tree, coat stand



**fish**

by Benedetta Mori Ubaldini  
→82



**trotter**

by Rogier Martens  
→109



**little big**

by Big+Game  
→91+93





trotter

by Rogier Martens

→109

## CARtools

by Floris Hovers  
→77

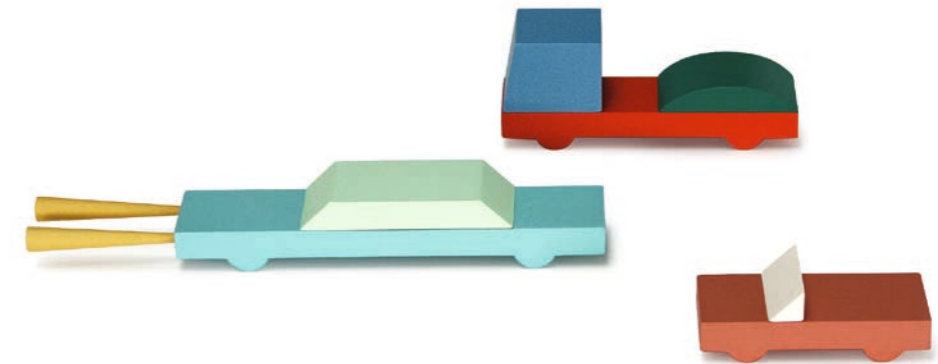

## *CARtools, fantastic vehicles that take shape from building blocks, for children of all ages.*

CARtools, fantásticos  
bóidos que toman forma  
como en un juego de  
construcción, para niños  
de todas las edades.

CARtools, de  
fantastiques bolides  
qui prennent forme  
comme dans un jeu de  
constructions, pour des  
enfants de tout âge.

CARtools, tolle  
Flitzer, die in einem  
Baukastenspiel Form  
annehmen, für Kinder  
jeden Alters.

CARtools, fantastici  
bolidi che prendono  
forma come in un gioco  
di costruzioni, per bambini  
di tutte le età.





**Birds are our friends:  
whatever their type or country  
of origin, it doesn't matter,  
because with them we all feel  
like Happy Bird.**

Los pájaros son nuestros amigos: no importa la raza o el país, junto a ellos nos sentimos todos Happy Bird.

Les oiseaux sont nos amis : peu importe leur race ou leur provenance, avec eux nous nous sentons tous des Happy Bird.

Vögel sind unsere Freunde: ihre Rasse und ihre Herkunft spielen keine Rolle, mit ihnen fühlen wir uns alle als Happy Bird.

Gli uccelli sono nostri amici: non importa la loro razza o il paese, insieme a loro ci sentiamo tutti degli Happy Bird.



**happy bird**

by Eero Aarnio  
→85



**happy bird**

by Eero Aarnio  
→86

Piedras, es decir un sofá, un sillón y una mesa casi iguales a los de los hombres primitivos, pero mucho más ligeros y cómodos.

Piedras : un divan, un fauteuil et une table basse presque identiques à ceux des hommes primitifs, mais beaucoup plus légers et confortables.

Piedras, oder ein Sofa, ein Lehnstuhl und ein kleiner Tisch, die aus der Steinzeit stammen könnten, nur dass sie viel leichter und bequemer sind.

Piedras, ovvero un divano, una poltrona e un tavolino quasi uguali a quelli degli uomini primitivi, ma molto più leggeri e comodi.

# piedras

by Javier Mariscal  
599

*Piedras, in other words  
a sofa, an armchair  
and a low table almost like  
those of primitive Man,  
but lighter and comfier.*





seggolina pop

by Enzo Mari  
→105



trioli

by Eero Aarnio  
→108



puppy

by Eero Aarnio  
→101



moments  
of  
ingenuity

by Oiva Toikka  
→95



eur

by Giulio Iacchetti  
→81



**Julian has seven lives:  
he's a cat, a chair, a toy...  
you invent the other four,  
together with lots of stories  
about the characters  
of the Ladrillos bookcase.**

Julián tiene siete vidas:  
es un gato, una silla, un  
juguete... las otras cuatro  
inventálas tú, junto a  
tantas otras historias  
con los personajes de la  
estantería Ladrillos.

Julian a sept vies :  
c'est un chat, une chaise,  
un jouet... les quatre  
autres, inventes-les toi,  
ainsi que de nombreuses  
autres histoires, avec  
les personnages de la  
bibliothèque Ladrillos.

Julian hat sieben  
Leben: Julian ist eine  
Katze, ein Stuhl, ein  
Spielzeug... die anderen  
vier kannst du selbst  
erfinden, gemeinsam  
mit vielen weiteren  
Geschichten mit den  
Helden des Bücherregals  
Ladrillos.

Julian ha sette vite:  
è un gatto, una sedia,  
un giocattolo... le altre  
quattro inventale tu,  
insieme a tante altre storie  
con i personaggi della  
libreria Ladrillos.



**julian**

by Javier Mariscal  
→87





**little flare**

by Marcel Wanders  
→94

**seggolina' pop**

by Enzo Mari  
→105

**puzzle carpet**

by Satyendra Pakhale  
→102



*Nido is a friendly monster,  
a protective shell,  
a den to shelter in and  
stretch out on your tummy,  
like lying on the grass.*



Nido es un monstruo bueno, un caparazón protector, una guarida en la que refugiarse y estar estirados boca abajo, como sobre la hierba.

Nido est un monstre gentil, une carapace de protection, une tanière dans laquelle se réfugier et rester allongé sur le dos, comme dans l'herbe.

Nido ist ein gutmütiges Ungetüm, eine schützende Schale, eine Höhle, in der man sich verkriechen und am Bauch liegen kann, wie auf einer Wiese.

Nido è un mostro buono, un guscio protettivo, una tana in cui rifugiarsi e stare distesi a pancia in giù, come sull'erba.



**nido**

by Javier Mariscal  
→97



**villa julia**  
by Javier Mariscal  
→110

## technical info



alma<sup>74</sup> birds<sup>75</sup> bunky<sup>76</sup> CARtools<sup>77</sup>  
clouds<sup>75</sup> dodo<sup>78</sup> downtown<sup>79</sup> el baúl<sup>80</sup>  
eur<sup>81</sup> fish<sup>82</sup> flying carpet<sup>83</sup> football tape<sup>84</sup>  
happy bird<sup>85-86</sup> julian<sup>87</sup> ladrillos<sup>88</sup>  
leaves<sup>89</sup> linus<sup>90</sup> little big<sup>91-93</sup>  
little flare<sup>94</sup> moments of ingenuity<sup>95</sup>  
my zoo<sup>96</sup> nido<sup>97</sup> paradise tree<sup>98</sup> piedras<sup>99</sup>  
pingy<sup>100</sup> puppy<sup>101</sup> puzzle carpet<sup>102</sup>  
rocky<sup>103</sup> the roof chair<sup>104</sup> seggiolina pop<sup>105</sup>  
summer to spring<sup>106</sup> tree<sup>107</sup>  
trioli<sup>108</sup> trotter<sup>109</sup> villa julia<sup>110</sup>

**Alma** — design Javier Mariscal, 2006

**Stacking children's chair**

*Material:* polypropylene with glass fibre added. Standard injection-moulded. Suitable for outdoor use.

→ image 06, 34/35, 36, 37



**Silla para niños apilable**

*Material:* polipropileno reforzado con fibra de vidrio moldeado por inyección estándar. Apta para el exterior.

**Chaise pour enfants empilable**

*Matériaux:* polypropylène chargé avec fibre de verre moulé par injection standard. Conçue pour l'extérieur.

**Kinderstuhl, stapelbar**

*Material:* Polypropylen mit Glasfaser verstärkt. Hergestellt im Standard-Einspritzverfahren. Auch für den Aussenbereich geeignet.

**Sedia per bambini impilabile**

*Materiale:* polipropilene caricato di fibra di vetro stampato ad iniezione standard. Adatta anche per esterni.

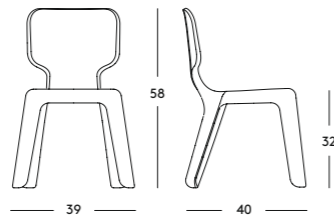

Matt colour  
Yellow 1037 C



Matt colour  
Green 1342 C



Matt colour  
Brown 1478 C



Matt colour  
White 1690 C

**Birds + Clouds** — design Benedetta Mori Ubaldini, 2012

**Birds + Clouds**

*Material:* metal mesh painted in epoxy resin. Supplied with hook for ceiling fixing.

→ image 16/17, 22 + 23

**Aves + Nubes**

*Material:* malla de alambre barnizada con pintura epoxi. Completa con gancho para fijar al techo.

**Oiseaux + Nuages**

*Matériaux:* haie métallique vernie en résine époxy. Fournie de crochet pour la fixation au plafond.

**Vögel + Wolken**

*Material:* Maschendraht, epoxylackiert. Komplett mit Befestigungshaken zur Deckenmontage.

**Uccelli + Nuvole**

*Materiale:* rete metallica verniciata in resina epossidica. Completa di gancio di fissaggio a soffitto.

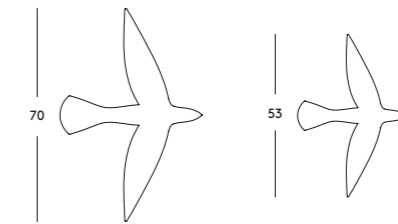

Birds

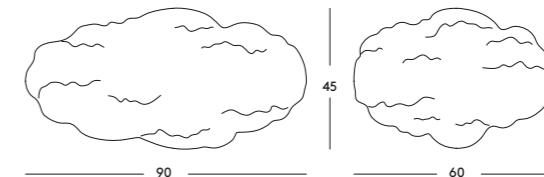
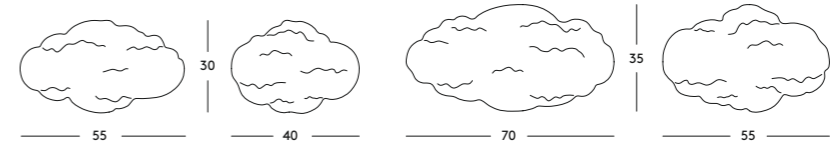

Clouds

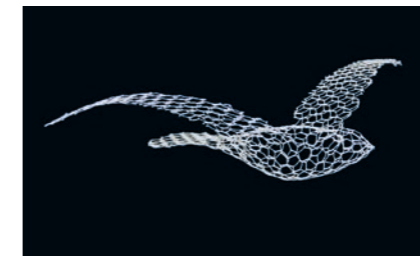

Matt colour  
Grey 5069

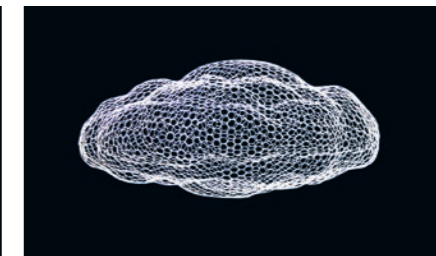

Matt colour  
White 5110

## Bunky — design Marc Newson, 2012

### Bed/bunk bed

*Material:* rotational-moulded polyethylene. Mattress, mattress cover, pillow, pillow cover and sheets also available.

→ [image 24/25](#)

### Cama/litera

*Material:* polietileno por moldeo rotacional. Disponible tambien colchon, funda de colchon, almohada, funda de almohada y juego de sábanas.

### Lit/lit superposé

*Matériaux:* polyéthylène moule par rotation. Matelas, drap-housse matelas, coussin, taie coussin et serie de draps aussi disponibles.

### Bett – Etagenbett

*Material:* Polyäthylen, hergestellt im Rotationsverfahren. Matratze, Spannbetttuch für Matratze, Kissen, Kissenbezug und Set von Bettlaken separat erhältlich.

### Letto/letto a castello

*Material:* polietilene stampato in rotational moulding. Disponibile anche materasso, coprimaterasso, cuscino, federa e set lenzuola.

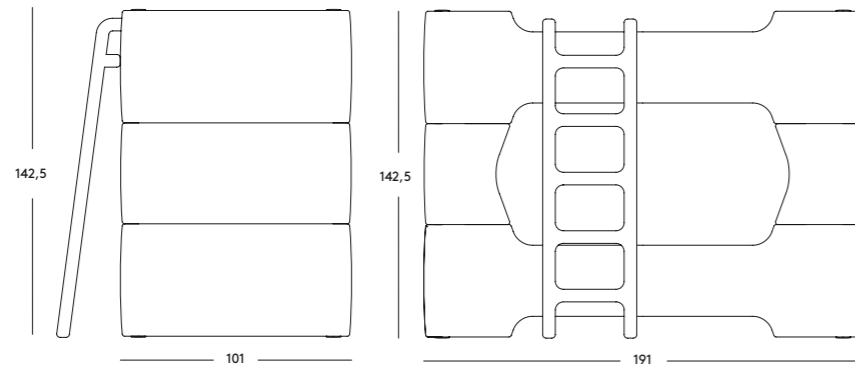

Bed 1 Dark blue 1232 C  
Stacking Unit Blue 1226 C  
Bed 2 Light blue 1218 C  
Ladder White 1736 C



Bed 1 Dark orange 1656 C  
Stacking Unit Orange 1654 C  
Bed 2 Light orange 1652 C  
Ladder White 1736 C

## CARtools — design Floris Hovers, 2015

### Puzzle Object (26 elements)

*Materials:* solid beech painted with non-toxic paints.

→ [image 56, 57](#)

### Objeto rompecabezas (26 elementos)

*Material:* madera maciza de haya barnizada con pinturas no tóxicas.

### Objet puzzle (26 éléments)

*Matériaux:* hêtre massif, teinté avec peintures non toxiques.

### Puzzle (26 Elementen)

*Materialien:* massive Buche, mit ungiftigen Farben lackiert.

### Oggetto puzzle (26 elementi)

*Materiali:* massello di faggio verniciato con sostanze atossiche.

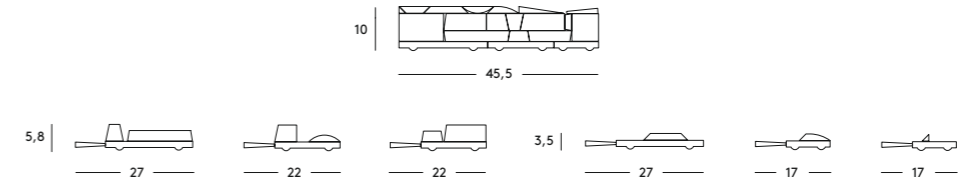

**Dodo** — design Oiva Toikka, 2009

**Rocking bird**

*Material:* rotational-moulded polyethylene. Suitable for outdoor use.

→ image 06, 43, 44/45



**Ave mecedora**

*Material:* polietileno por moldeo rotacional. Apto para el exterior.

**Oiseau à bascule**

*Matériaux:* polyéthylène moulé par rotation. Conçu pour l'extérieur.

**Schaukelvogel**

*Material:* Polyäthylen. Hergestellt im Rotationsverfahren. Auch für den Aussenbereich geeignet.

**Uccello a dondolo**

*Materiale:* polietilene in rotational moulding. Adatto anche per esterni.

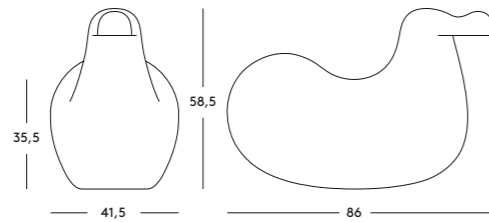

Matt colour  
Red 1004 C



Matt colour  
Yellow 1025 C



Matt colour  
Blue 1252 C



Matt colour  
White 1735 C

**Downtown** — design Oiva Toikka, 2011

**Shelving system**

*Material:* rotational-moulded polyethylene. Suitable for outdoor use.

→ image 19, 37



**Biblioteca**

*Material:* polietileno por moldeo rotacional. Apto para el exterior.

**Bibliothèque**

*Matériaux:* polyéthylène moulé par rotation. Conçue pour l'extérieur.

**Regalsystem**

*Material:* Polyäthylen. Hergestellt im Rotationsverfahren. Auch für den Aussenbereich geeignet.

**Libreria**

*Materiale:* polietilene stampato in rotational moulding. Adatto anche per esterni.

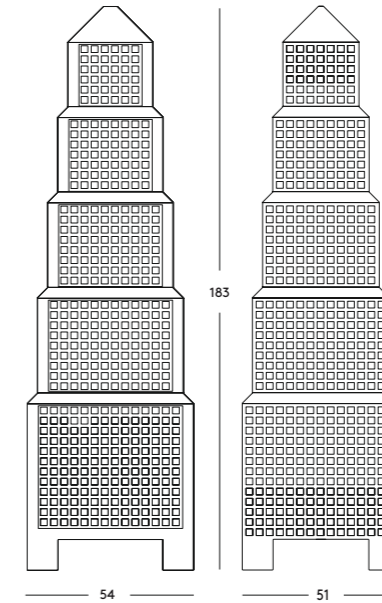

Matt colour  
White 1736 C

**El Baúl** — design Javier Mariscal, 2005

Trunk/container

Material: rotational-moulded polyethylene.

→ image 12, 13

Baúl/contenedor

Material: polietileno por moldeo rotacional.

Coffre

Matériaux: polyéthylène moulé par rotation.

Box

Material: Polyäthylen. Hergestellt im Rotationsverfahren.

Baule contenitore

Material: polietilene stampato in rotational moulding.

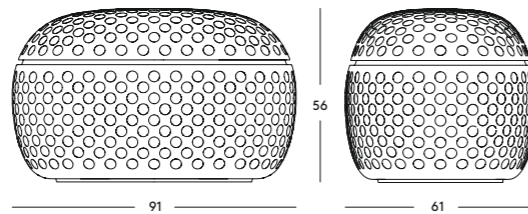

Matt colour  
White 1700 C

**Eur** — design Giulio Iacchetti, 2013

Shelving system. Stacking and adjoining

Material: sintered expanded polypropylene.

→ image 32, 33, 62/63

Librería modular apilable y arrimable

Material: polipropileno expandido sinterizado.

Étagère modulable

Matériaux: polypropylène expansé sintérisé.

Modulares Ragalsystem, stapelbar und addierbar

Material: gesintertes geschäumtes Polypropylen.

Modulo libreria, impilabile ed accostabile

Material: polipropilene espanso sinterizzato.

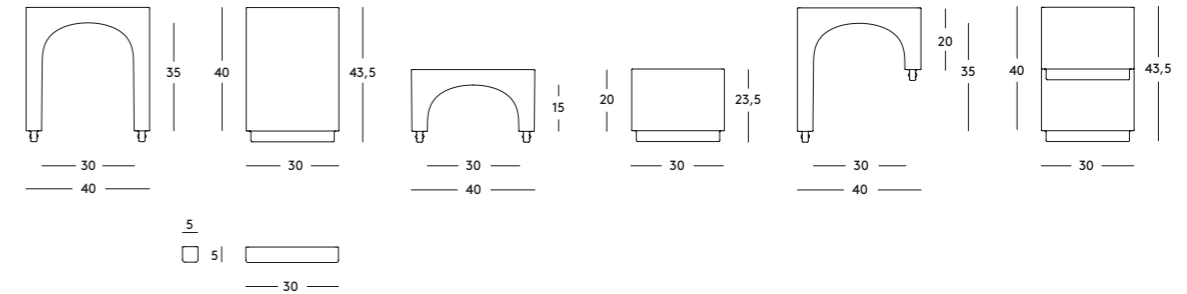

Examples of Composition



Colour  
Terracotta 1092 C

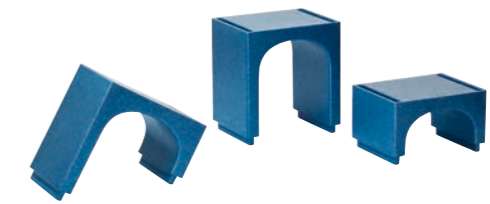

Colour  
Blue 1606 C

**Fish** — design Benedetta Mori Ubaldini, 2016

**Fish**

*Material:* metal mesh painted in epoxy resin. Supplied with hook for ceiling fixing.

→ image 50, 52/53

**Peces**

*Material:* malla de alambre barnizada con pintura epoxi. Completa con gancho para fijar al techo.

**Poissons**

*Matériaux:* haie métallique vernie en résine époxy. Fournie de crochet pour la fixation au plafond.

**Fische**

*Material:* Maschendraht, epoxylackiert. Komplett mit Befestigungshaken zur Deckenmontage.

**Pesci**

*Materiale:* rete metallica verniciata in resina epossidica. Completa di gancio di fissaggio a soffitto.

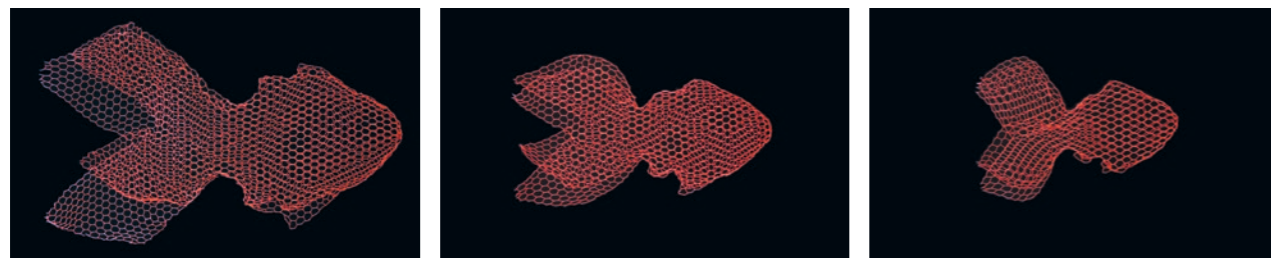
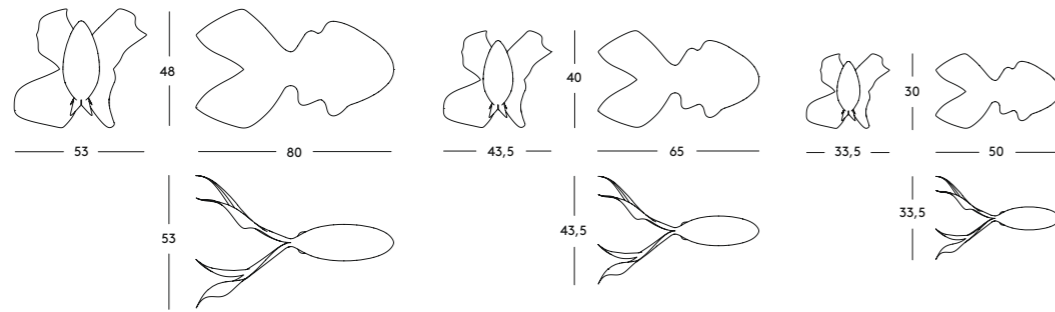

Matt colour  
Fluorescent Red 5088

**Flying Carpet** — design Eero Aarnio, 2006

**Flying carpet  
Rocking**

*Material:* base in rotational-moulded polyethylene. Suitable for outdoor use. Option extra: carpet in coloured polyamide.

→ image 28/29

**Alfombra voladora**  
Plataforma con movimiento oscilatorio circular.

*Material:* plataforma en polietileno por moldeo rotacional. Apta para el exterior. Extras: alfombra en poliamida colorada.

**Tapis volant**  
Plateforme à bascule.

*Matériaux:* plateforme en polyéthylène moulé par rotation. Conçu pour l'extérieur. Optionnel: tapis en polyamide coloré.

**Fliegender Teppich**  
Schwingende Plattform.

*Material:* Plattform aus Polyäthylén. Hergestellt im Rotationsverfahren. Auch für den Aussenbereich geeignet. Optional: Teppich aus farbigem Polyamid.

**Tappeto volante**  
Piattaforma con movimento oscillatorio circolare.

*Materiale:* piattaforma in polietilene stampato in rotational moulding. Adatto anche per esterni. Optional: tappeto in poliammide colorato.

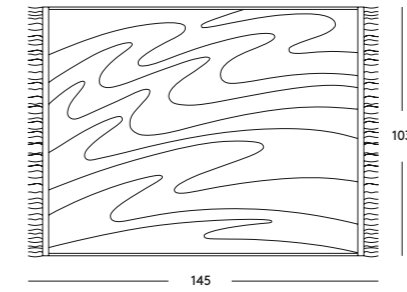
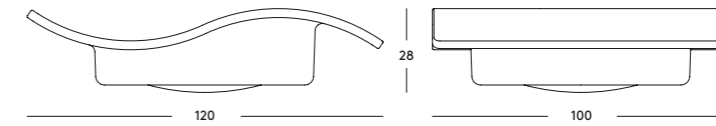

Matt colour  
White 1700 C

## Football Tape — design Martí Guixé, 2004

Adhesive tape to make paper balls

*Material:* acrylic polypropylene. Non-toxic.

→ image 08, 09

Cinta adhesiva para crear balones de papel

*Material:* polipropileno acrílico. No tóxico.

Ruban adhésif pour faire des ballons en papier

*Matériaux:* polypropylène acrylique. Non toxique.

Klebeband, um Papierbälle zu machen

*Material:* Acrylpolypropylen. Atoxisch.

Nastro adesivo per creare palloni di carta

*Materiale:* polipropilene acrilico. Atossico.

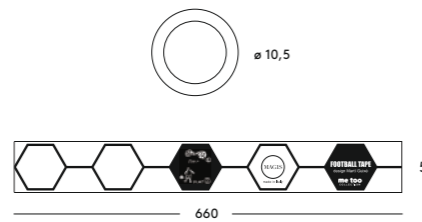

## Happy Bird — design Eero Aarnio, 2015

Abstract bird

*Material:* rotational-moulded polyethylene. Suitable for outdoor use

→ image 58



Ave abstracto

*Materiales:* polietileno por moldeo rotacional. Apto para el exterior.

Oiseau abstrait

*Matériaux:* polyéthylène moulé par rotation. Conçu pour l'extérieur.

Abstrakter Vogel

*Materialien:* Polyäthylen. Hergestellt im Rotationsverfahren. Auch für den Aussenbereich geeignet.

Uccello astratto

*Materiale:* polietilene stampato in rotational moulding. Adatto anche per esterni.

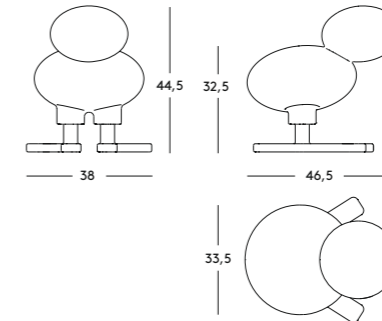

Body + Paws Yellow 1665 C



Body White 1735 C  
Paws Yellow 1665 C

## Happy Bird — design Eero Aarnio, 2015

### Abstract bird

*Material:* rotational-moulded polyethylene. Paws in natural solid ash.

→ image 59

### Ave abstracto

*Materiales:* polietileno por moldeo rotacional. Patas en madera maciza de fresno.

### Oiseau abstrait

*Matériaux:* polyéthylène moulé par rotation. Pattes en frêne massif naturel.

### Abstrakter Vogel

*Materialien:* Polyäthylen. Hergestellt im Rotationsverfahren. Pfote aus massiver Esche naturfarben.

### Uccello astratto

*Materiale:* polietilene stampato in rotational moulding. Zampe in massello di frassino naturale.

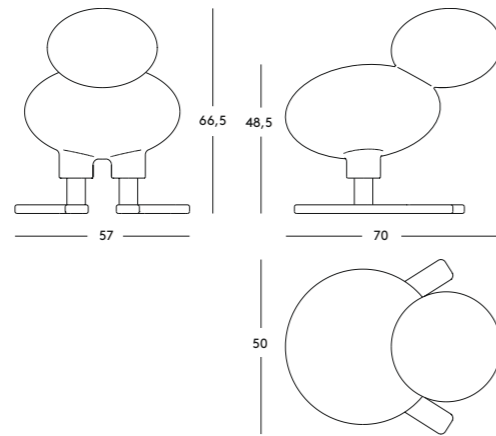

Body Yellow 1665 C  
Paws Natural Ash



Body White 1735 C  
Paws Natural Ash



Body Orange 1085 C  
Paws Natural Ash

## Julian — design Javier Mariscal, 2005

### Children's chair

*Material:* rotational-moulded polyethylene. Suitable for outdoor use.

→ image 64, 65



### Silla para niños

*Material:* polietileno por moldeo rotacional. Apta para el exterior.

### Chaise pour enfants

*Matériaux:* polyéthylène moulé par rotation. Conçue pour l'extérieur.

### Kinderstuhl

*Material:* Polyäthylen. Hergestellt im Rotationsverfahren. Auch für den Aussenbereich geeignet.

### Sedia per bambini

*Materiale:* polietilene stampato in rotational moulding. Adatta anche per esterni.

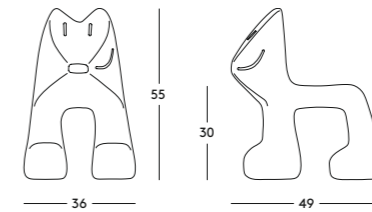

Matt colour  
Red 1122 C



Matt colour  
Green 1290 C



Matt colour  
Yellow 1665 C



Matt colour  
White 1735 C

**Ladrillos** — design Javier Mariscal, 2005

**Shelving system**

*Material:* shelf supports in rotational-moulded polyethylene. Shelves in HPL white with black edge.

→ image 51, 65

**Libreria modular**

*Material:* ladrillos en polietileno por moldeo rotacional. Estantes en HPL blanco, borde negro.

**Système d'étagère**

*Matériaux:* briques en polyéthylène moulé par rotation. Plateaux en HPL blanc avec bord noir.

**Regalsystem**

*Material:* Abstandshalter aus Polyäthylen. Hergestellt im Rotationsverfahren. Ablagen aus HPL weiss mit schwarzer Kante.

**Libreria componibile**

*Materiali:* mattoni in polietilene stampato in rotational moulding. Piani in HPL bianco con bordo nero.

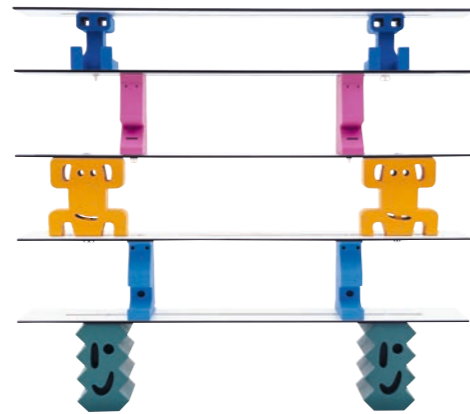
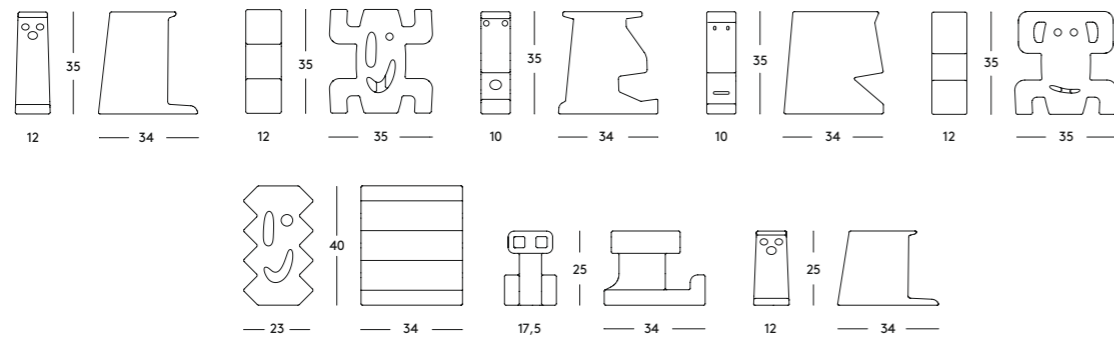
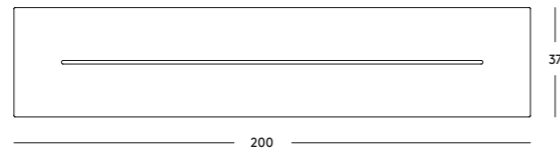

Shelf Supports Nik fuchsia 1006 C   Shelf Supports Nomo yellow 1025 C   Shelf Supports Nomi orange 1085 C   Shelf Supports Nono light blue 1220 C   Shelf Supports Nosi blue 1252 C   Shelf Supports Sino dark green 1281 C   Shelf Supports Nok green 1360 C   Shelf Supports Nolu pink 1623 C

**Leaves** — design Blaise Drummond, 2017

**Set of art serigraphies**

Two colours art serigraphy printed on Fabriano Rosaspina 285 gr. paper, 100% cotton.

→ image 15, 18

**Serie de serigrafias**

Serigrafía de arte en 2 colores impresos en papel Fabriano Rosaspina 285 gr., 100% algodón.

**Série de sérigraphies**

Sérigraphie d'art à 2 couleurs imprimée sur papier Fabriano Rosaspina 285 gr., 100% coton.

**Serie von Serigraphien**

Zweifarbige Kunstserigraphie, auf Fabriano Rosaspina 285 gr. Papier gedruckt, 100% Baumwolle.

**Serie di serigrafie**

Serigrafia d'arte a due colori stampata su carta Fabriano Rosaspina 285 gr., 100% cotone.

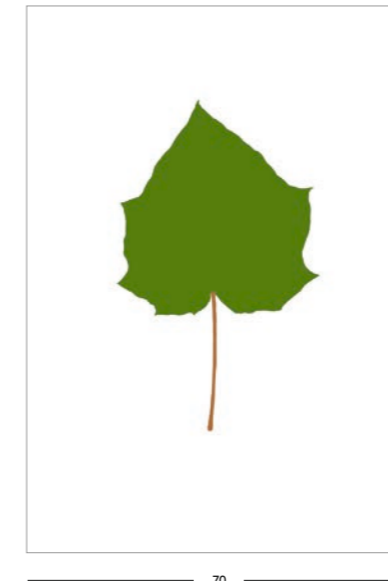

Paulownia tomentosa  
(Paulownia)

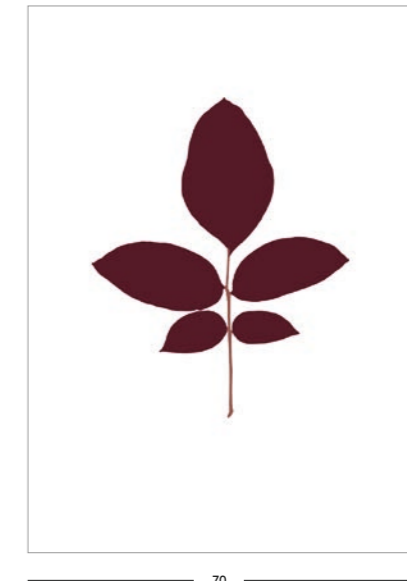

Juglans  
(Walnut)

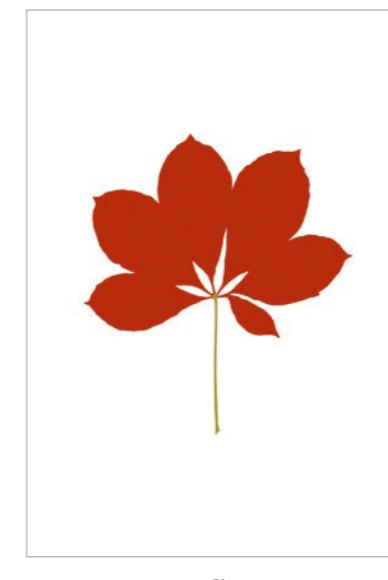

Castanea sativa  
(Chestnut)

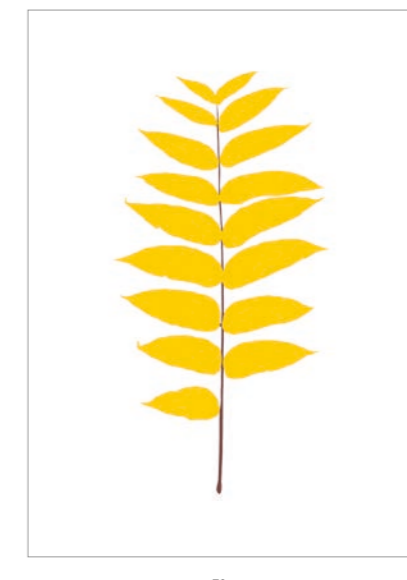

Juglans nigra  
(American walnut)

**Linus** — design Javier Mariscal, 2006

**Children's tables**

*Material:* legs in polypropylene with glass fibre added. Standard injection-moulded. Top in MDF with polymeric cover.

→ image 15, 34/35, 37

**Mesas para niños**

*Material:* patas en polipropileno reforzado con fibra de vidrio moldeado por inyección estándar. Tablero en MDF cubierto con lámina polimérica.

**Tables pour enfants**

*Matériaux:* pieds en polypropylène chargé avec fibre de verre moulé par injection standard. Plateau en MDF avec revêtement en polymère.

**Kindertische**

*Material:* Gestell aus Polypropylen mit Glasfaser verstärkt. Hergestellt im Standard-Einspritzverfahren. Tischplatte aus MDF mit polymerer Folie überzogen.

**Tavoli per bambini**

*Materiali:* gambe in polipropilene caricato di fibra di vetro stampato ad iniezione standard. Piano in MDF rivestito di foglia polimerica.

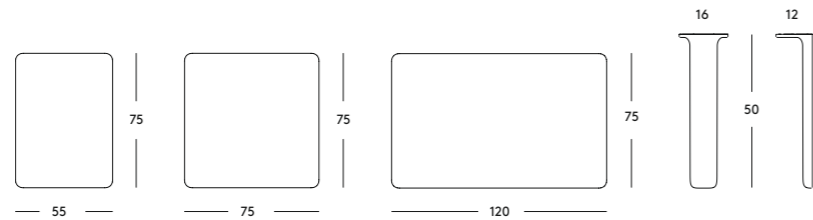

Matt colour  
White 1690 C

**Little Big** — design Big-Game, 2017

**Chair, adjustable in height**

*Material:* frame in solid ash, natural. Seat in polypropylene.

→ image 15, 52/53

**Silla con altura regulable**

*Material:* estructura de madera maciza de fresno natural. Asiento de polipropileno.

**Chaise réglable en hauteur**

*Matériaux:* structure en frêne massif, naturel. Assise en polypropylène.

**Stuhl, höhenverstellbar**

*Material:* Gestell aus massiver Esche naturfarben. Sitz aus Polypropylen.

**Sedia regolabile in altezza**

*Materiale:* struttura in massello di frassino naturale. Sedile in polipropilene.

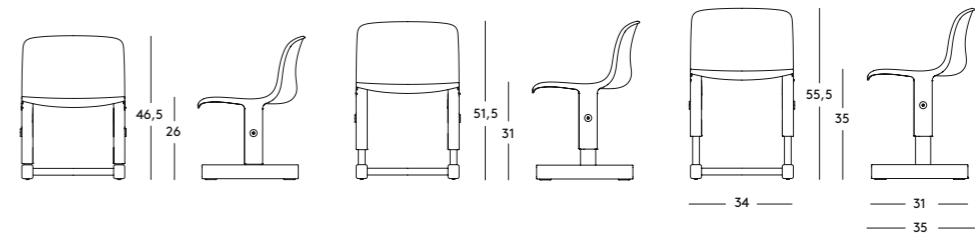

Frame Natural Ash  
Seat White 1735 C



Frame Natural Ash  
Seat Light Blue 1256 C



Frame Natural Ash  
Seat Orange 1086 C

**Distorting mirrors**  
1 flat, 1 concave,  
1 convex

*Material:* frame in solid ash, natural. Reflective sheet in polymethylmethacrylate (PMMA), back-silvered.

→ image 14, 41

**Espejos deformantes**  
1 llano, 1 cóncavo,  
1 convexo

*Material:* estructura de madera maciza de fresno natural. Lámina reflectante de polimetilmetacrilato (PMMA) retroplateada.

**Miroirs déformants**  
1 plane, 1 concave,  
1 convexe

*Matériaux:* structure en frêne massif, naturel. Plaque reflectante en polyméthylméthacrylate (PMMA), argenté sur le dos.

**Lachende Spiegel**  
1 flach, 1 konkav,  
1 konvex

*Material:* Gestell aus aus massiver Esche, naturfarben. Platte aus Polymethylmethacrylat (PMMA), auf der Rückseite versilbert.

**Specchi deformanti**  
1 piano, 1 concavo,  
1 convesso

*Materiali:* struttura in massello di frassino naturale. Lastra riflettente in polimetilmetacrilato (PMMA) retroargentata.

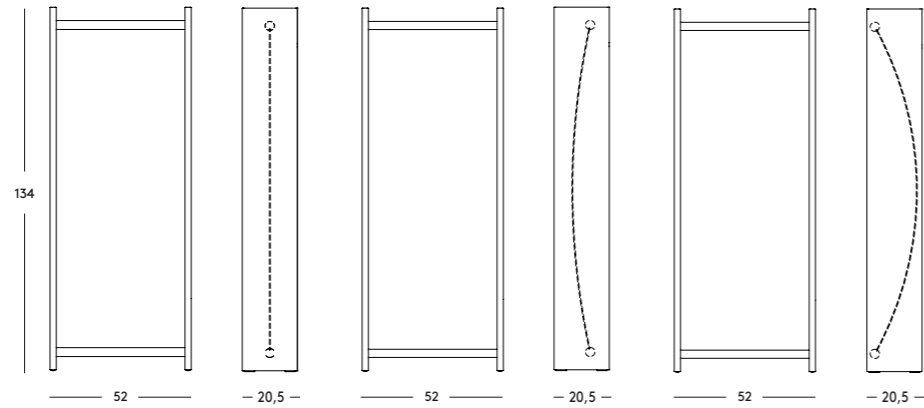

Frame Natural Ash

**Table adjustable in height**

*Material:* legs in solid ash, natural. Frame in painted steel. Top in HPL.

→ image 52/53

**Mesa con altura regulable**

*Material:* patas de madera maciza de fresno natural. Estructura de acero barnizado. Tablero de HPL.

**Table réglable en hauteur**

*Matériaux:* pieds en frêne massif, naturel. Structure en acier verni. Plateau en HPL.

**Tisch, höhenverstellbar**

*Material:* Beine aus massiver Esche, naturfarben. Gestell aus lackiertem Stahl. Tischplatte aus HPL.

**Tavolo regolabile in altezza**

*Materiale:* gambe in massello di frassino naturale. Struttura in acciaio verniciato. Piano in HPL.

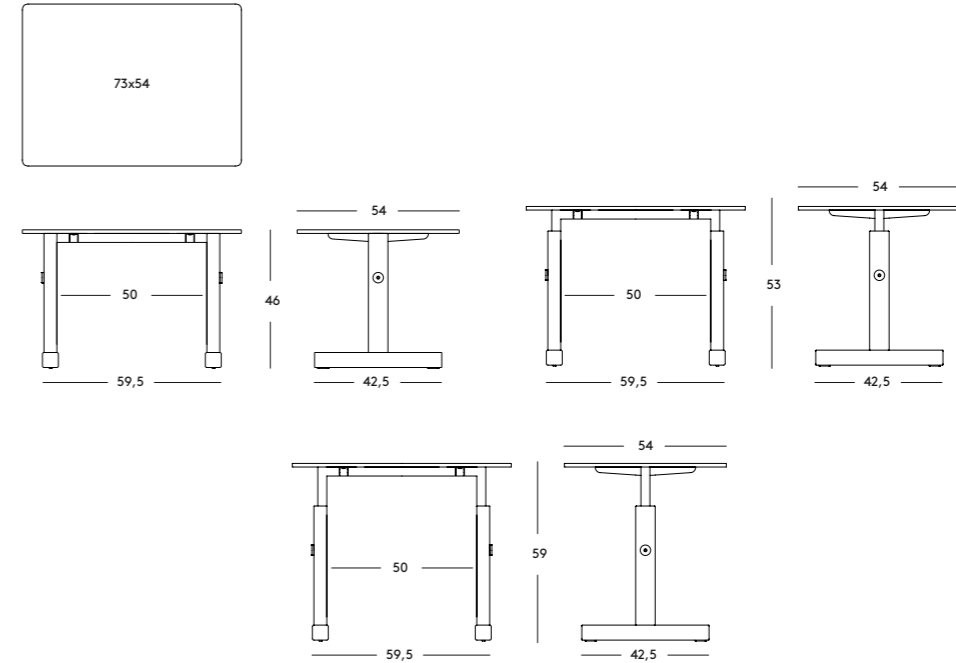

Frame Natural Ash  
Top White 1735 C

**Little Flare — design Marcel Wanders, 2005**

**Children's table**

*Material:* legs in standard injection-moulded polycarbonate transparent clear. Tops in MDF with white polymeric cover. Patterned tops also available. Pen holders in ABS. Sketch book available with patterns to be completed and coloured.

→ image 30, 31, 66/67

**Mesa para niños**

*Material:* patas en policarbonato transparente neutro moldeado por inyección estándar. Tablero en MDF recubierto con lámina polimérica blanca. Disponible también tablero decorado. Portaplapices en ABS. Disponible también álbum con gráficas para completar y colorear.

**Table pour enfants**

*Matériaux:* pieds en polycarbonate transparent cristal, moulé par injection standard. Plateaux en MDF avec revêtement en polymère blanc. Plateaux décorés sont aussi disponibles. Porte-plumes en ABS. Disponible aussi album avec décorations à compléter et colorier.

**Kindertisch**

*Material:* Tischbeine aus transparentem Polykarbonat, farblos. Hergestellt im Standard-Einspritzverfahren. Tischplatten aus MDF mit weiss polymerer Folie überzogen. Tischplatten auch mit Dekoren erhältlich. Stiftbox aus ABS. Skizzenblock separat erhältlich.

**Tavolo per bambini**

*Materiali:* gambe in policarbonato trasparente neutro stampato ad iniezione standard, piano di MDF rivestito di foglia polimerica bianco. Piano anche con decori. Vaschette portapenne in ABS. Disponibile album con grafiche da completare e colorare.

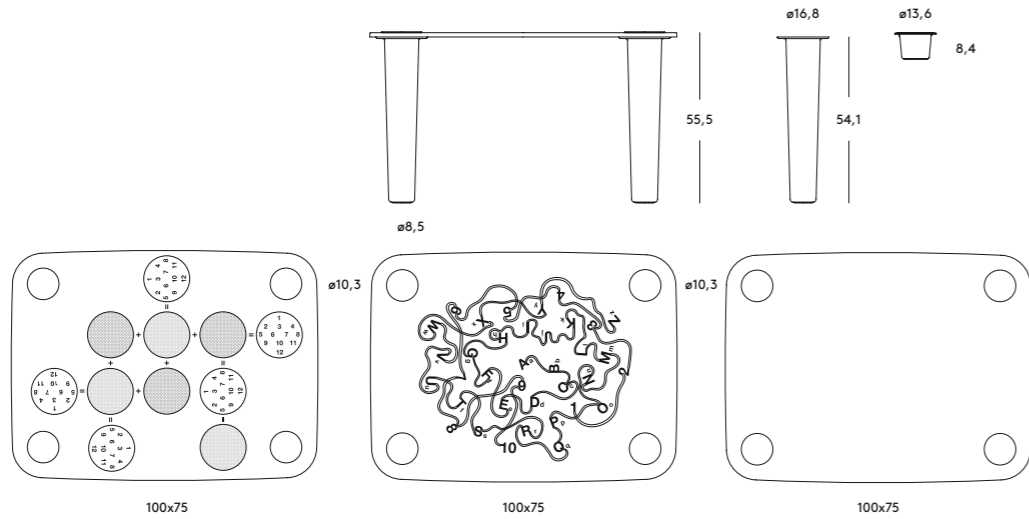

**Circle**  
Top White 8500  
Pen Holder + Feet Orange 1001 C



**Salad**  
Top White 8500  
Pen Holder + Feet Orange 1001 C

**Moments of Ingenuity — design Oiva Toikka, 2011**

**Serigraphy**

Five colours (The Elephants) or seven colours (The Camel and the Ostrich) art serigraphy, printed on Fabriano Rosaspina 285 gr paper and mounted on a MDF support.

→ image 16/17, 62/63

**Serigrafía**

Serigrafía de arte en 5 colores (Los Elefantes) o en 7 colores (El Camello y el Avestruz) impreso en papel Fabriano Rosaspina de 285 gr y montado en un soporte de MDF.

**Sérigraphie**

Sérigraphie d'art à 5 couleurs (Les Éléphants) ou à 7 couleurs (Le Chameau et l'Atruche) imprimée sur papier Fabriano Rosaspina 285 gr et montée sur support en MDF.

**Serigraphie**

Fünffarbige (Die Elefanten) oder siebenfarbige (Das Kamel und der Strauss) Kunstserigraphie, auf Fabriano Rosaspina 285 gr. Papier gedruckt und auf ein MDF Tafel geklebt.

**Serigrafia**

Serigrafia d'arte a 5 colori (Gli Elefanti) o 7 colori (Il Cammello e lo Struzzo) stampata su carta Fabriano Rosaspina 285 gr e montata su supporto di MDF.

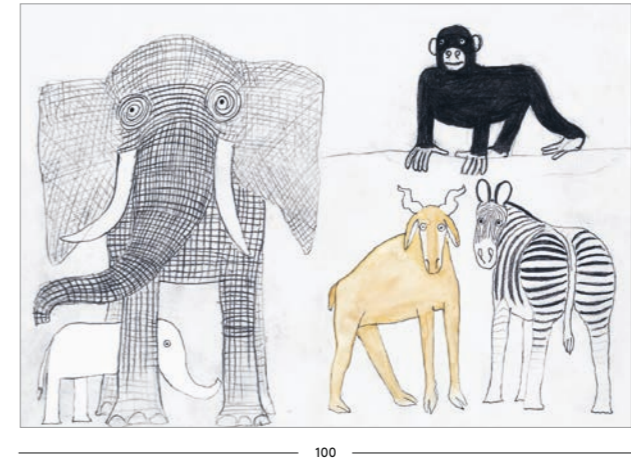

**The Elephants**

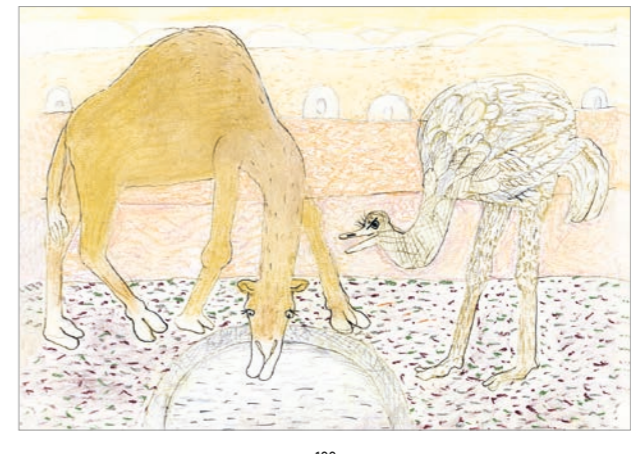

**The Camel and the Ostrich**

**My Zoo — design Martí Guixé, 2012**

**Animal figures**      **Figuras de animales**      **Figures d'animaux**      **Tierfiguren**      **Figure di animali**  
*Material: cardboard.*      *Material: cartón.*      *Matériaux: carton.*      *Material: Karton.*      *Materiale: cartone.*

→ image 26/27

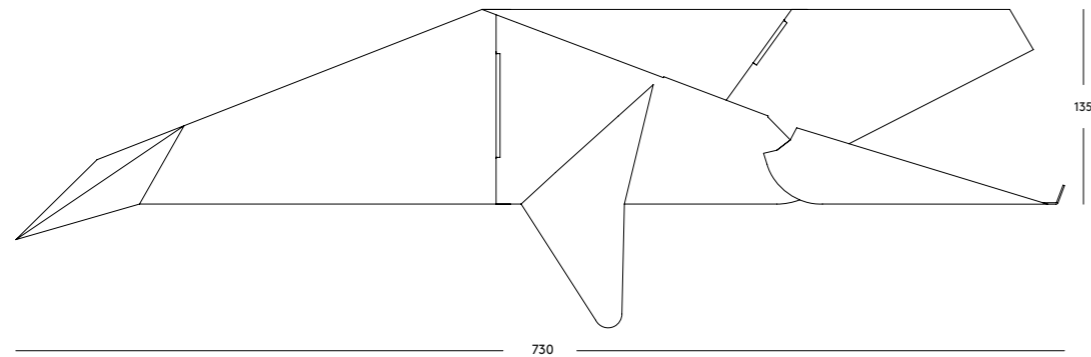
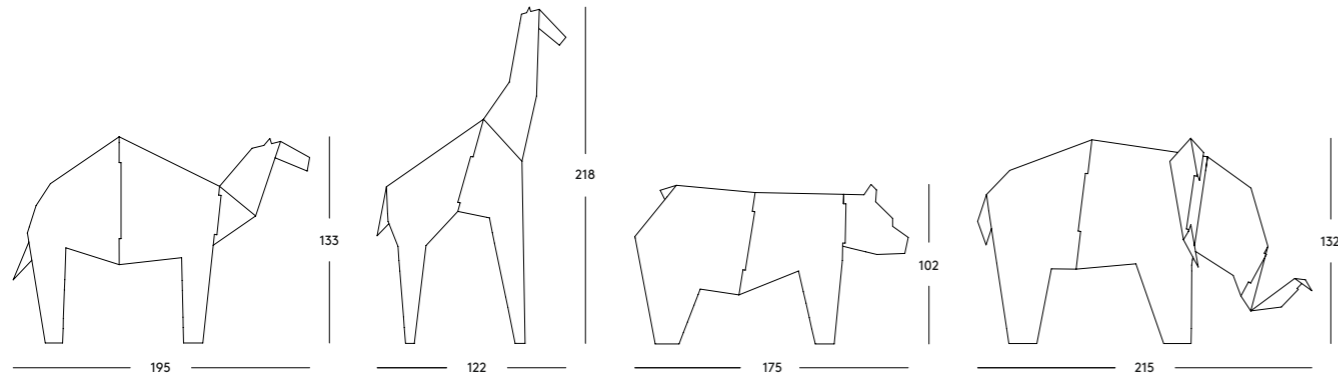
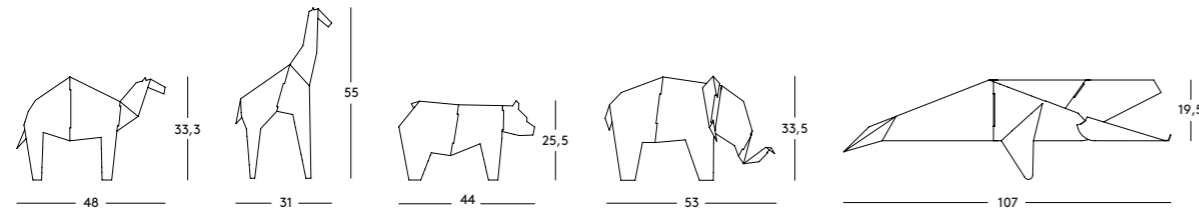

**Nido — design Javier Mariscal, 2005**

**Nest/cave**      **Guarida**      **Nid/repaire**      **Höhle**      **Tana**  
*Material: rotational-moulded polyethylene.* Floor with grass style pattern and graffiti on underside of roof. Suitable for outdoor use.  
*Material: polietileno por moldeo rotacional.* Suelo con diseño de hierba y techo con graffiti. Apto para el exterior.  
*Matériaux: polyéthylène moulé par rotation.* Sol avec décoration herbe et plafond avec graffiti. Conçu pour l'extérieur.  
*Material: Polyäthylen.* Hergestellt im Rotationsverfahren. Fussboden mit grasähnlichem Dekor, Decke mit Graffiti. Auch für den Aussenbereich geeignet.  
*Materiale: polietilene stampato in rotational moulding.* Pavimento con disegno erba e soffitto con graffiti. Adatta anche per esterni.

→ image 68/69

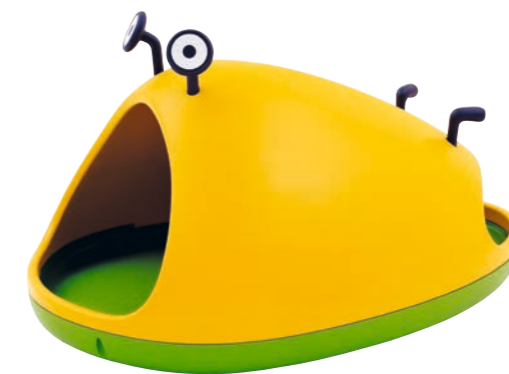
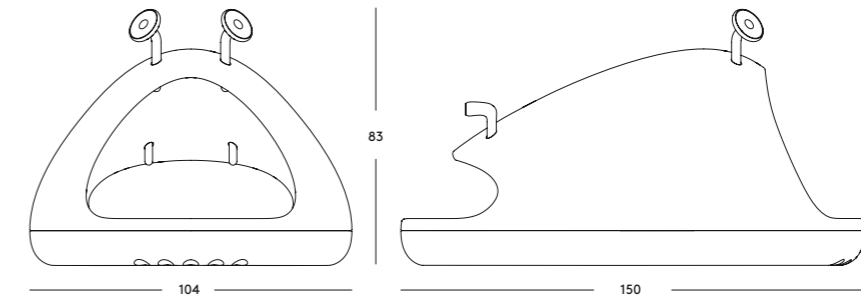

Roof Yellow 1025 C  
 Base Green 1290 C  
 Antennae Grey anthracite 1420 C

**Paradise Tree — design Oiva Toikka, 2009**

**Coat stand**

*Material:* elements in rotational-moulded polyethylene. Weight and inner frame in galvanized steel.

→ image 42, 51

**Percha de pie**

*Material:* polietileno por moldeo rotacional. Lastre y estructura interior en acero cincado en frío.

**Porte-manteaux**

*Matériaux:* polyéthylène moulé par rotation. Lest et structure intérieure en acier galvanisé.

**Kleiderständer**

*Material:* Polyäthylen. Hergestellt im Rotationsverfahren. Gewicht und Innengestell aus verzinktem Stahl.

**Appendiabiti**

*Materiali:* polietilene stampato in rotational moulding. Zavorra e struttura interna in acciaio zincato a freddo.

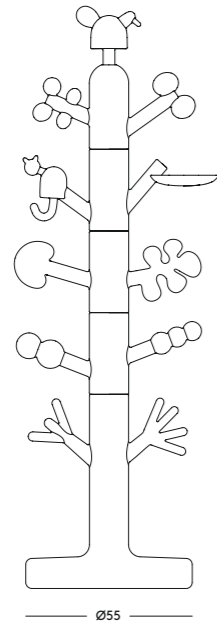
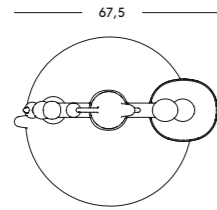

- Red 1004 C
- White 1735 C
- Blue 1220 C
- Green 1360 C
- Yellow 1665 C
- Orange 1001 C

Matt colour

**Piedras — design Javier Mariscal, 2006**

**Low chair, bench and low table**

*Material:* rotational-moulded polyethylene. Suitable for outdoor use.

→ image 60/61



**Sillón, sofá y mesita**

*Material:* polietileno por moldeo rotacional. Aptos para el exterior.

**Fauteuil, canapé et petite table**

*Matériaux:* polyéthylène moulé par rotation. Conçus pour l'extérieur.

**Niedriger Stuhl, Sofa und niedriger Tisch**

*Material:* Polyäthylen. Hergestellt im Rotationsverfahren. Auch für den Aussenbereich geeignet.

**Poltroncina, divanetto e tavolino**

*Materiale:* polietilene stampato in rotational moulding. Adatta anche per esterni.

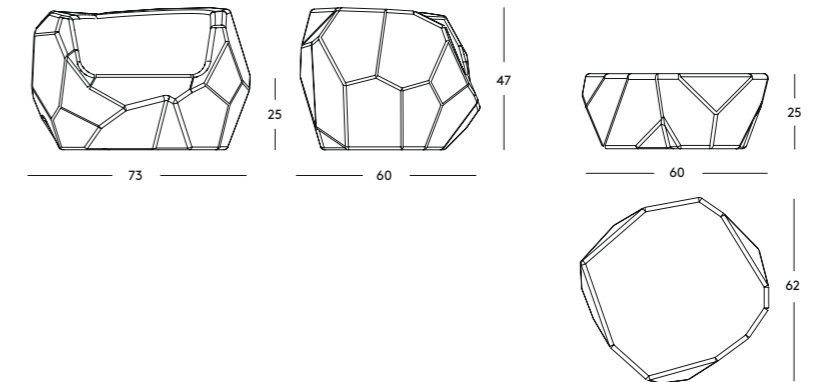
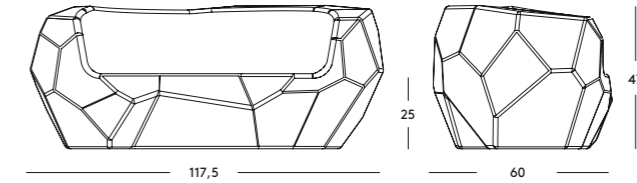

Matt colour  
Grey anthracite 1407 C

**Pingy — design Eero Aarnio, 2011**

**Penguin**

Materials: rotational-moulded polyethylene.

→ image 20/21

**Pingüino**

Material: polietileno por moldeo rotacional.

**Pingouin**

Matériaux: polyéthylène moulé par rotation.

**Pinguin**

Materialien: Polyäthylen. Hergestellt im Rotationsverfahren.

**Pinguino**

Material: polietilene stampato in rotational moulding.

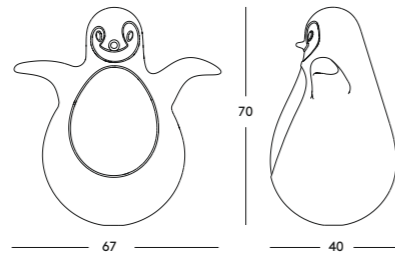

Matt colour  
Black 1763 C

**Puppy — design Eero Aarnio, 2005**

**Abstract plastic dog**

Material: rotational-moulded polyethylene. Suitable for outdoor use.

→ image 30, 33, 38, 39, 46, 47, 62/63



**Perro abstracto**

Material: polietileno por moldeo rotacional. Apto para el exterior.

**Chien abstrait**

Matériaux: polyéthylène moulé par rotation. Conçu pour l'extérieur.

**Abstrakter Hund**

Material: Polyäthylen. Hergestellt im Rotationsverfahren. Auch für den Aussenbereich geeignet.

**Cane astratto**

Material: polietilene stampato in rotational moulding. Adatto anche per esterni.

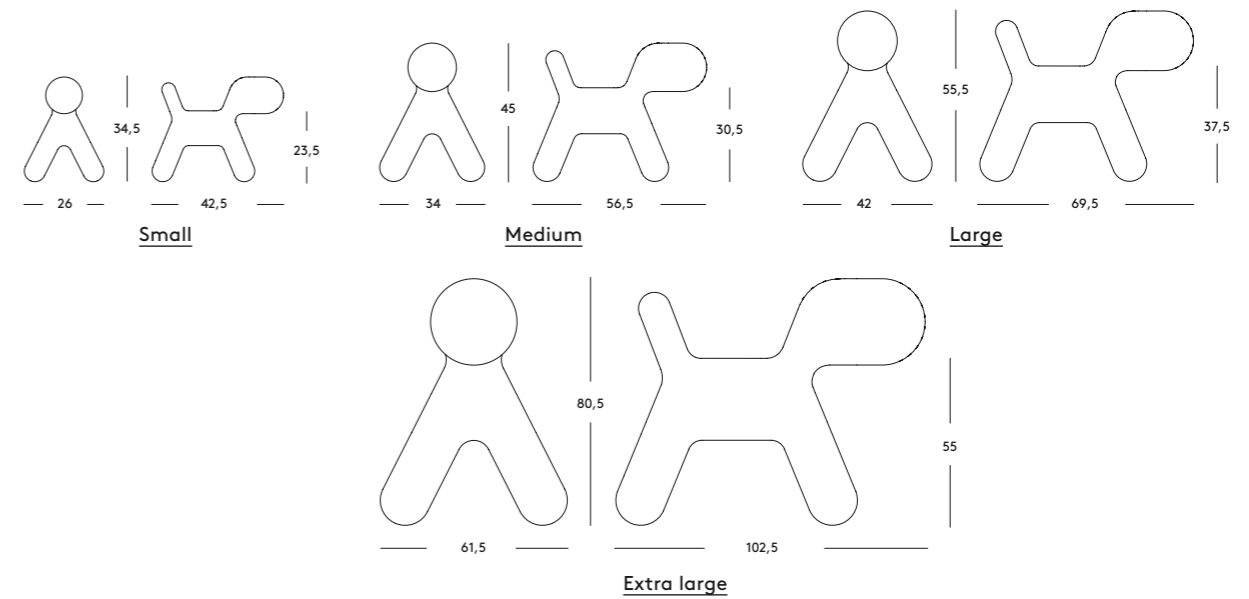

Matt colour  
Orange 1001 C



Matt colour  
Green 1360 C



Matt colour  
White 1700 C



Matt colour  
Dalmatian

**Puzzle carpet** — design Satyendra Pakhalé, 2005

**Puzzle carpet**

*Material:* soft expanded polyethylene coupled with polyester fabric.

→ [image 23, 66/67](#)

**Azulejo/alfombra**

*Material:* polietileno expandido morbido cubierto con tela de poliéster.

**Tapis/puzzle**

*Matériaux:* polyéthylène expansé souple avec tissu en polyester.

**Puzzle/Teppich**

*Material:* weiches geschäumtes Polyäthylen mit Polyesterstoff.

**Piastrella/tappeto**

*Materiale:* polietilene espanso morbido accoppiato di tessuto poliester.

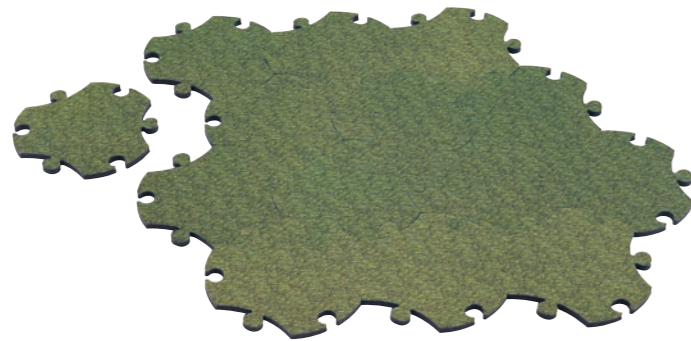
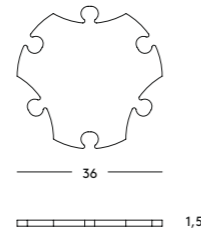

**Patterns**  
Water



**Patterns**  
Sand



**Patterns**  
Grass

**Rocky** — design Marc Newson, 2012

**Rocking horse**

*Material:* rotational-moulded polyethylene. Rein in natural hemp rope.

→ [image 10](#)

**Caballo balancín**

*Material:* polietileno por moldeo rotacional. Rienda de cáñamo natural.

**Cheval à bascule**

*Matériaux:* polyéthylène moulé par rotation. Rêne en corde de chanvre naturel.

**Schaukelpferd**

*Material:* Polyäthylen, hergestellt im Rotationsverfahren. Zügel aus Natur-Hanf.

**Cavallo a dondolo**

*Materiale:* polietilene stampato in rotational moulding. Redine in corda di canapa naturale.

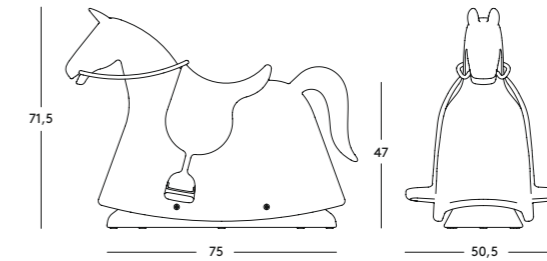

**Matt colour**  
Brown 1069 C



**Matt colour**  
White 1736 C



**Matt colour**  
Black 1768 C

## The Roof Chair — design Spalvieri & Del Ciotto, 2018

### Low chair

*Material:* frame in aluminium tube. Central crossbar covered in flexible expanded polyurethane. Cover in polyester.

→ image 38, 39, 40, 41

### Sillón

*Material:* estructura de tubo de aluminio. Larguero central cubierta de poliuretano expandido flexible. Rivestimiento de poliéster.

### Petit fauteuil

*Matériaux:* structure en tube d'aluminium. Traverse centrale revetue en polyurethane expansé flexible. Revêtement en polyester.

### Sessel

*Material:* Gestell aus Aluminiumrohr. Zentrale Querstrebe aus flexiblem geschäumtem Polyurethan. Bezug aus Polyester.

### Poltroncina

*Materiale:* struttura in tubo di alluminio. Traversa centrale rivestita in poliuretano espanso flessibile. Rivestimento in poliester.

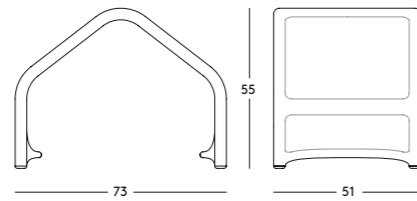

Colour  
Green Blue



Colour  
Orange

## Seggiolina Pop — design Enzo Mari, 2004

### Children's chair

*Material:* expanded polypropylene.

→image 06, 10/11, 30, 31, 62/63, 66/67

### Silla para niños

*Material:* polipropileno expandido.

### Chaise pour enfant

*Matériaux:* polypropylène expansé.

### Kinderstuhl

*Material:* geschäumtes Polypropylen.

### Sedia per bambini

*Materiale:* polipropilene espanso.

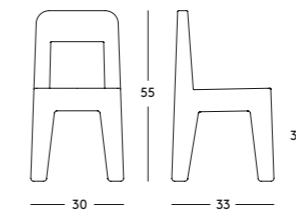

Matt colour  
Orange 1082 C



Matt colour  
Blue 1606 C



Matt colour  
Green 1638 C

## Summer to Spring – design El Ultimo Grito, 2005

Collection of children's clothes

100% made in Italy. Available in three different sizes (for children ages 2 to 7).

Material: cotton.

→ image 48/49

Colección de ropa para niños

100% hecha en Italia. Disponible en tre tallas (para niños de 2 a 7 años).

Material: algodón.

Collection de vêtements pour enfants

100% made in Italy. Disponible en trois tailles différentes (pour enfants de 2 à 7 ans).

Matériaux: coton.

Kinderkollektion

100% made in Italy. In drei verschiedenen Größen erhältlich (für Kinder von 2 bis 7 Jahren).

Material: Baumwolle.

Abbigliamento per bambini

100% made in Italy. Disponibile in tre taglie (per bambini dai 2 ai 7 anni).

Materiale: cotone.

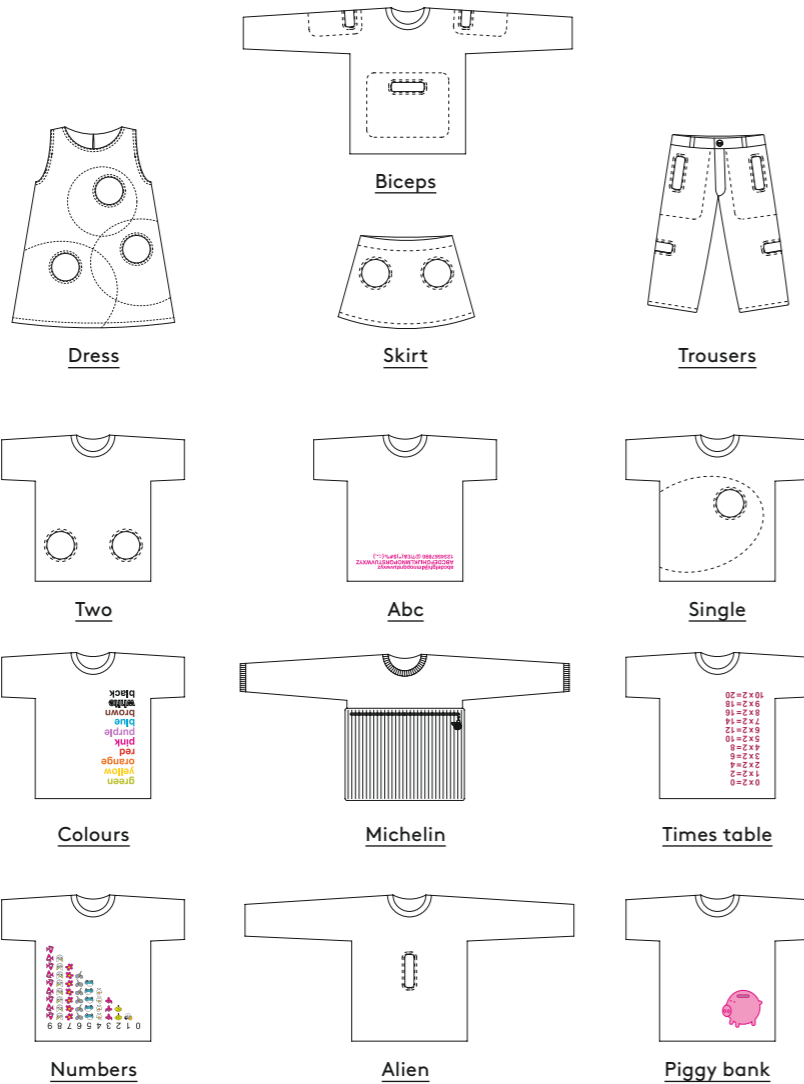

## Tree – design Blaise Drummond, 2018

Set of art serigraphies

Set of art serigraphies printed on Fabriano Rosaspina 285 gr. paper, 100% cotton.

→ image 06, 07

Serie de serigrafias

Serie de serigrafias de arte impresas en papel Fabriano Rosaspina de 285 gr., 100% algodón.

Serie de sérigraphies

Serie de sérigraphies d'art imprimées sur papier Fabriano Rosaspina 285 gr. 100% coton.

Serie von Kunstserigraphien

Serie von Kunstserigraphien auf Fabriano Rosaspina 285 gr. Papier gedruckt, 100% Baumwolle.

Serie di serigrafie

Serie di serigrafie d'arte su carta Fabriano Rosaspina 285 gr. 100% cotone.

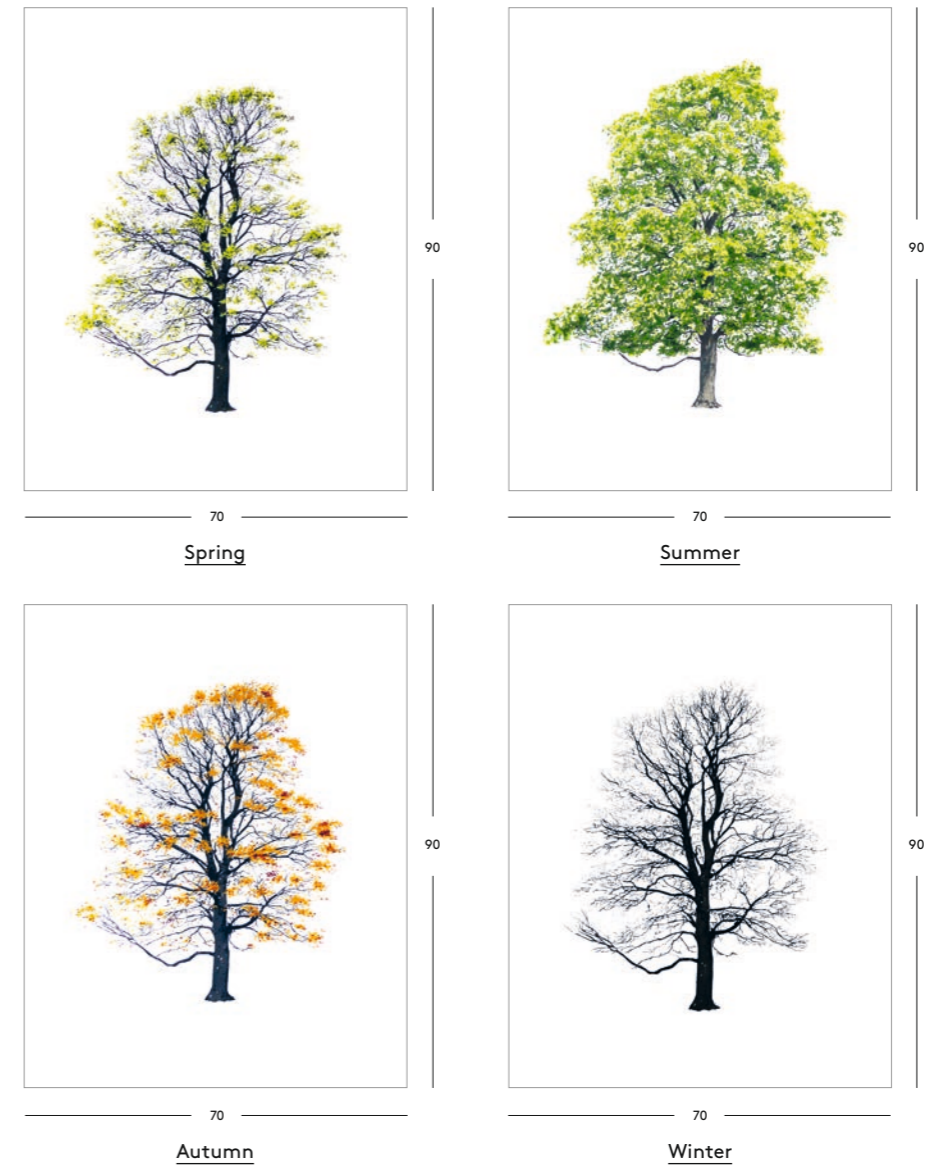

## Trioli — design Eero Aarnio, 2005

### Children's chair

*Material:* rotational-moulded polyethylene. Two different seat heights. It can also be used as a rocker. Suitable for outdoor use.

→ image 62



### Silla para niños con tres posibles usos

*Material:* polietileno por moldeo rotacional. También se puede usar como mecedora. Apta para el exterior.



### Chaise pour enfants

*Matériaux:* polyéthylène moulé par rotation. Deux différentes hauteurs d'assise. La chaise peut être utilisée aussi comme cheval à bascule. Conçue pour l'extérieur.

### Kinderstuhl

*Material:* Polyäthylen. Hergestellt im Rotationsverfahren. Zwei verschiedene Sitzhöhen. Der Stuhl kann auch als Wippe benutzt werden. Auch für den Aussenbereich geeignet.

### Sedia per bambini a tre usi: alta, bassa e cavallo a dondolo

*Materiale:* polietilene stampato in rotational moulding. Adatta anche per esterni.

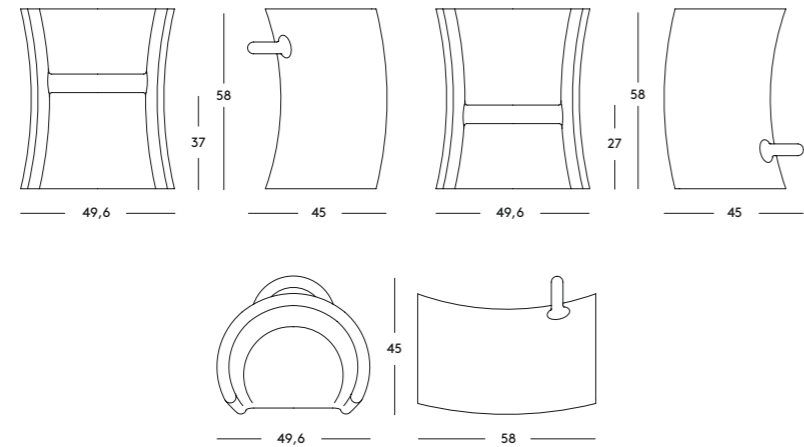

Matt colour  
Red 1004 C



Matt colour  
Blue 1252 C



Matt colour  
Yellow 1665 C

## Trotter — design Rogier Martens, 2015

### Children's chair

*Material:* frame in steel rod painted in polyester powder. Wheel and handles in polypropylene.

→ image 52/53, 54, 55

### Silla para niños

*Material:* estructura en barra de acero barnizado poliéster. Rueda y perillas de polipropileno.

### Chaise pour enfants

*Matériaux:* structure en fil d'acier verni en polyester. Roue et poignée en polypropylène.

### Kinderstuhl

*Material:* Gestell aus polyesterlackiertem Stahldraht. Rad und Griffen aus Polypropylen.

### Sedia per bambini

*Materiali:* struttura in tondino di acciaio verniciato poliester. Ruota e manopole in polipropilene.

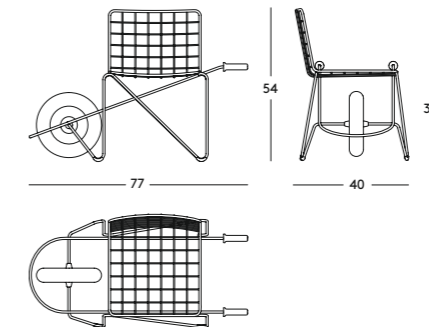

Frame Green  
Wheel Orange

## Villa Julia — design Javier Mariscal, 2009

### Small house

Material: cardboard.  
Complete with stickers  
for personalization.

→ [image 70/71](#)

### Casita

Material: cartón.  
Dotada de pegatinas para  
la personalización.

### Petite maison

Matériaux: carton.  
Fourni avec adhésifs pour  
la personnalisation.

### Kleines Haus

Material: Karton. Komplett  
mit Aufklebern zur  
Eigengestaltung.

### Casetta

Materiale: cartone.  
Completa di adesivi per  
la personalizzazione.

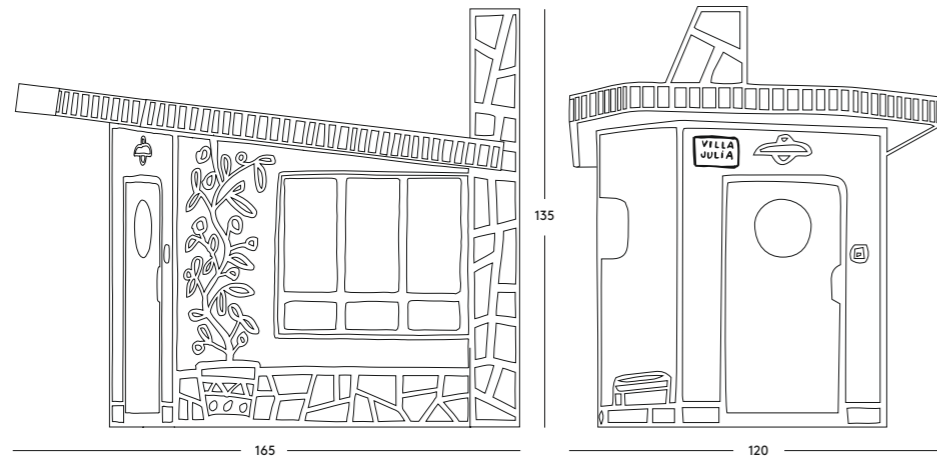

Matt colour  
White

All rights reserved.  
No part of this publication may  
be reproduced, stored  
in a retrieval system  
or transmitted, in any form  
or by any means, electronic,  
mechanical, photocopyng,  
recording or otherwise, without  
the prior permission of Magis  
Spa.  
Magis reserves the right to  
introduce any changes  
to its own models, without  
prior notice.

Graphic design:  
Designwork

Photography:  
location  
Pasquale Abbatista  
Max Rommel  
still life  
Tom Vack  
Alessandro Milani  
post producer  
Studio Dilux

Styling:  
Ilaria Bacciocchi  
Vanda Gemino  
Thanks to:  
Scuola Primaria  
Cecilia Danieli, Buttrio  
Nido Scuola  
Clorofilla, Milano  
Luceplan  
CC Tapis  
Fate i capricci  
Tondo Mondo  
Città del Sole  
Design Republic  
Civette sul comò

Colour separation  
Lucegroup  
Printed in Italy by  
Sincromia, Pordenone

@Magis Spa 2018

# Roltrade

**Maahatuonti ja tiedustelut:**

**Oy Roltrade Ab**  
**Vattuniemenkatu 3 - 00210 Helsinki**  
**Puh. 010 322 0500**  
**roltrade@roltrade.com**  
**www.roltrade.com**

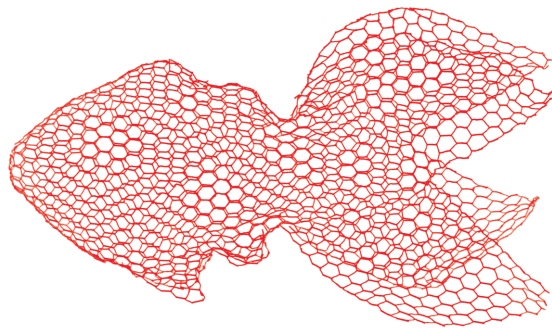

**Me too, yo también,  
moi aussi,  
ich auch, anch'io...**